

USER'S MANUAL

 **SOUND STORM**
LABORATORIES

 **SOUND STORM**
LABORATORIES

3451 LUNAR COURT, OXNARD CA 93030
PHONE: 805.983.8008
FAX: 805.983.7068

TECHNICAL SUPPORT:
ssltech@soundstormlab.com

soundstormlab.com

SDVD900
IN-DASH DVD/MP3/CD AM/FM RECEIVER
WITH MOTORIZED FLIP-OUT 6.5" WIDE SCREEN TFT MONITOR
AND TV TUNER

4.2005

SDVD900
IN-DASH DVD/MP3/CD AM/FM RECEIVER
WITH MOTORIZED FLIP-OUT 6.5" WIDE SCREEN TFT MONITOR
AND TV TUNER

FEATURES

Compatible with PAL DVD (Video CD) and NTSC DVD (Video CD)

This player can play discs recorded in either PAL or NTSC format.

- A single LSI chip now integrates all major DVD playback circuit functions including MPEG2 decoder, video D/A converter, and audio decoders.
- L/R stereo analog audio outputs for connection to existing head unit aux inputs. Video output is composite video.
- Supplied remote handles multi-function software (multi-language audio-track/subtitle, multi-angle, multi-story, etc.), plus all basic functions.

USE THIS PRODUCT SAFELY

This set has been designed and manufactured to assure personal safety. Improper use can result in electric shock or fire hazard. The safeguards incorporated in this unit protect you if you observe the following procedures for installation, use and servicing. This unit doesn't contain any parts that can be repaired by the user.

When Driving

Keep the volume level low enough to be aware of road and traffic conditions.

When Car Washing

Do not expose the product to water or excessive moisture. This could cause electrical shorts, fire or other damage.

When Parked

Parking in direct sunlight can produce very high temperatures inside your vehicle. Give the interior a chance to cool down before starting playback.

Use the Proper Power Supply

This product is designed to operate with a 12 volt DC, negative ground battery system (the regular system in a North American car).

Protect the Disc Mechanism

Avoid inserting any foreign objects into the slot of this player.

Failure to observe this may cause malfunction due to the precise mechanism of this unit.

Use Authorized Service Centres

Do not attempt to disassemble or adjust this precision product. Please refer to the Service Centre list included with this product for service assistance.

For Installation

The unit should be installed in a horizontal position with the front end up at a convenient angle, but not more than 30°.

Protect the monitor mechanism

- The monitor opens and closes using a motorized mechanism. Do not pull or push on the monitor or turn it in any way by hand. Doing so will damage the mechanism and may leave the unit inoperable.
- When operating the unit with the remote control keep your hands and other objects away from the unit. Failure to do so may result in injury to you or damage to the unit.

CONTENTS

Safety Information	4
Disc Notes	5
Installation	6
The Player	8
Front View	8
Back View	9
The Tuner Box	9
Electrical Connection	10
Remote Control	11
Location and Function of Keys	11
Preparing the Remote Control	13
Loading/ Ejecting a disc	13
Loading a disc	13
Ejecting a Disc	13
Operation	14
Basic Operation	14
Disc (DVD, VCD, CD, MP3) Operation	16
Radio Operation	20
TV Operation	21
AV Operation	22
RGB Operation	22
Setup	23
Initial Setup	23
General Setup	23
Speaker Setup	25
Audio Setup	25
Preferences Setup	26
Defaults Table	28
Trouble Shooting	29
Specifications	30



SAFETY INFORMATION

CAUTION:

MOBILE DVD PLAYER IS A CLASS I LASER PRODUCT. HOWEVER THIS MOBILE DVD PLAYER USES A VISIBLE/INVISIBLE LASER BEAM WHICH COULD CAUSE HAZARDOUS RADIATION EXPOSURE IF DIRECTED. BE SURE TO OPERATE THE MOBILE DVD PLAYER CORRECTLY AS INSTRUCTED. USE OF CONTROLS OR ADJUSTMENTS OR PERFORMANCE OF PROCEDURES OTHER THAN THOSE SPECIFIED HEREIN MAY RESULT IN HAZARDOUS RADIATION EXPOSURE. DO NOT OPEN COVERS AND - DO NOT REPAIR YOURSELF. REFER SERVICING TO QUALIFIED PERSONNEL.

WARNING:

- TO REDUCE THE RISK OF FIRE OR ELECTRIC SHOCK, DO NOT EXPOSE THIS EQUIPMENT TO RAIN OR MOISTURE.
- TO REDUCE THE RISK OF FIRE OR ELECTRIC SHOCK, AND ANNOYING INTERFERENCE, USE ONLY THE RECOMMENDED ACCESSORIES.
- THIS DEVICE IS INTENDED FOR CONTINUOUS OPERATION.

This product incorporates copyright protection technology that is protected by method claims of certain U.S. patents and other intellectual property rights owned by Macrovision Corporation and other rights owners. Use of this copyright protection technology must be authorized by Macrovision Corporation, and is intended for home and other limited viewing uses only unless otherwise authorized by Macrovision Corporation. Reverse engineering or disassembly is prohibited.

REGION MANAGEMENT INFORMATION

Region Management Information: This Mobile DVD Player is designed and manufactured to respond to the Region Management Information that is recorded on a DVD disc. If the Region number described on the DVD disc does not correspond to the Region number of this Mobile DVD Player, this Mobile DVD Player cannot play this disc.

DISC NOTES

Disc formats supported by this player



DVD
12 cm disc
(Single-sided disc only)



VIDEO CD
12 cm disc



CD
12 cm disc



MP3
12 cm disc

Discs which cannot be played with this player

- DVD-ROM
- DVD-R/DVD-RAM
- CDV
- CD-G

Handling and Cleaning

- Dirt, dust, scratches and warping disc will cause misoperation.
- Do not place stickers or make scratches on discs.
- Do not warp discs.
- A disc should always be kept in its case when not in use to prevent from damaging.
- Do not place discs in the following places:
 1. Direct sunlight
 2. Dirty, dusty and damp areas
 3. Near car heaters
 4. On the seats or dashboard

Disc Cleaning

Use a dry soft cloth to wipe the surface. If the disc is quite dirty, use a soft cloth slightly moistured with isopropyl (rubbing) alcohol. Never use solvents such as benzine, thinner or conventional record cleaners as they may mar the surface of the disc.

Note:

A disc may become somewhat scratched (although not enough to make it

unusable) depending on your handle it and conditions in the usage environment. Note these scratches are not an indication of any problem with the player.

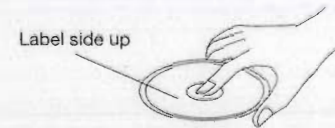

Label side up

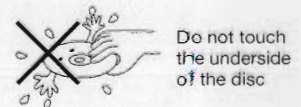

Do not touch the underside of the disc



Do not bend



Wipe the disc from center toward the outside edge

Preparing New Discs with Rough Spots

A new disc may have rough edges on its inside and outside edges. If a disc with rough edges is used, the proper setting will not be performed and the player will not play the disc. Therefore, remove the rough edges in advance by using a ball point pen or pencil as shown on the right. To remove the rough edges, press the side of the pen or pencil against the inside and outside edges of the disc.

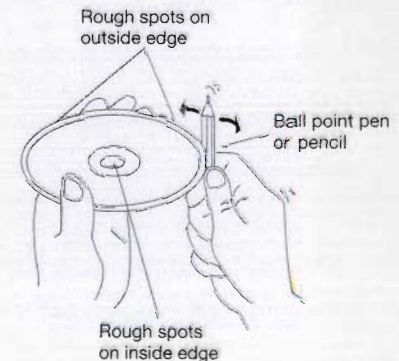

Notes:

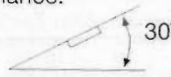
- Choose the mounting location where the unit will not interfere with the normal driving function of the driver.
 - Before final installation of the unit, connect the wiring temporarily and make sure it is all connected up properly and the unit and the system work properly.
 - Use only the parts included with the unit to ensure proper installation. The use of unauthorized parts can cause malfunctions.
 - Consult with your nearest dealer if installation requires the drilling of holes or other modifications of the vehicle.
 - Install the unit where it does not get in the driver's way and cannot injure the passenger if there is a sudden stop, like an emergency stop.
 - If installation angle exceeds 30° from horizontal, the unit might not give its optimum performance.
- 
- Avoid installing the unit where it would be subject to high temperature, such as from direct sunlight, or from hot air, from the heater, or where it would be subject to dust, dirt or excessive vibration.

DIN FRONT/REAR-MOUNT

This unit can be properly installed either from "Front" (conventional DIN Front-mount) or "Rear" (DIN Rear-mount installation, utilizing threaded screw holes at the sides of the unit chassis). For details, refer to the following illustrated installation methods.

DIN FRONT-MOUNT (Method A)

Installation Opening

This unit can be installed in any dashboard having an opening as shown below:

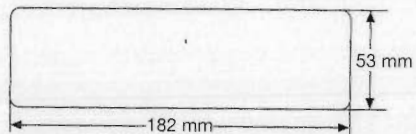

Installing the unit

Be sure you test all connections first, and then follow these steps to install the unit.

1. Make sure the ignition is turned off, and then disconnect the cable from the vehicle battery's negative (-) terminal.
2. Disconnect the wire harness and the antenna.
3. Lift the top of the outer trim ring then pull it out to remove it.
4. The two supplied keys release tabs inside the unit's sleeve so you can remove it. One key is for the right side and the other is for the left side. Insert the keys as far as they will go (with the notches facing up) into the appropriate slots at the middle left and right sides of the unit. Then slide the sleeve off the back of the unit.

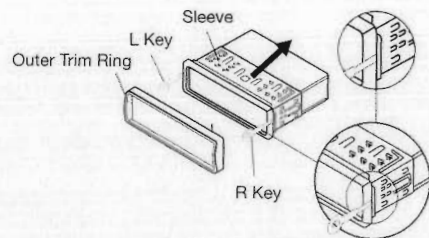

5. Mount the sleeve by inserting the sleeve into the opening of the dashboard and bend open the tabs located around the sleeve with a screwdriver. Not all tabs will be able to make contact, so examine which ones will be most effective. Bend out the appropriate

tabs behind the dashboard to secure the sleeve in place.

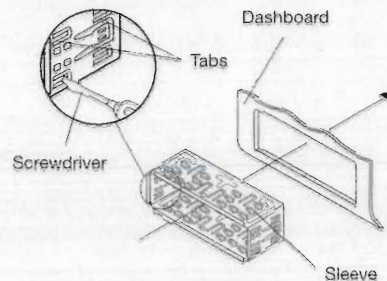

6. Connect the wire harness and the antenna and be careful not to pinch any wires or cables.
7. Slide the unit into the sleeve until it locks into place.
8. To further secure the unit, use the supplied metal strap to secure the back of the unit in place. Use the supplied hardware (Hex Nut (M5mm) and Spring Washer) to attach one end of the strap to the mounting bolt on the back of the unit. If necessary, bend the metal strap to fit your vehicle's mounting area. Then use the supplied hardware (Tapping Screw (5x25mm) and Plain Washer) to attach the other end of metal strap to a solid metal part of the vehicle under the dashboard. This strap also helps ensure proper electrical grounding of the unit.

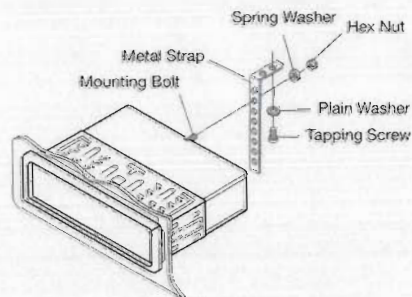

9. Reconnect the cable to the vehicle battery's negative (-) terminal. Then replace the outer trim ring.

Removing the unit

1. Make sure the ignition is turned off, then disconnect the cable from the vehicle battery's negative (-) terminal.
2. Remove the metal strap attached the back of the unit (if attached).
3. Lift the top of the outer trim ring then pull it out to remove it.
4. Insert both of the supplied keys into the slots at the middle left and right sides of the unit, then pull the unit out of the dashboard.

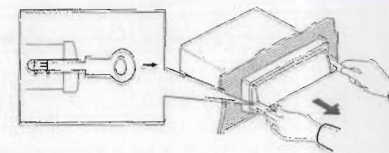

DIN FRONT-MOUNT (Method B)

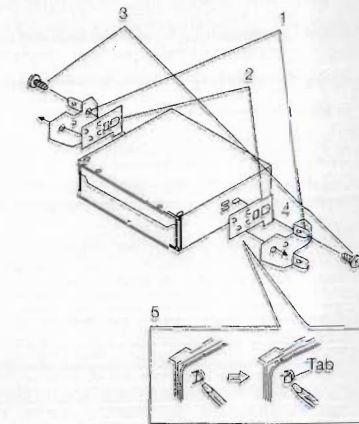

1. Factory-installed radio bracket
2. Car radio mounting bracket
3. Screw
4. After aligning the car radio mounting bracket with the factory-installed radio bracket, tighten the screws (5x5mm) at 2 places on each side.
5. When attaching the factory-installed radio bracket with the screws, use a standard-tipped screwdriver to bend open the tabs of the car radio mounting bracket to make them fit into the holes in the factory-installed radio bracket.

THE PLAYER

FRONT VIEW

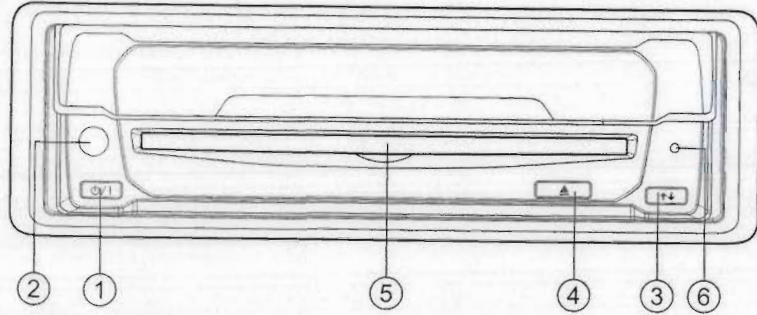

With monitor in open position:

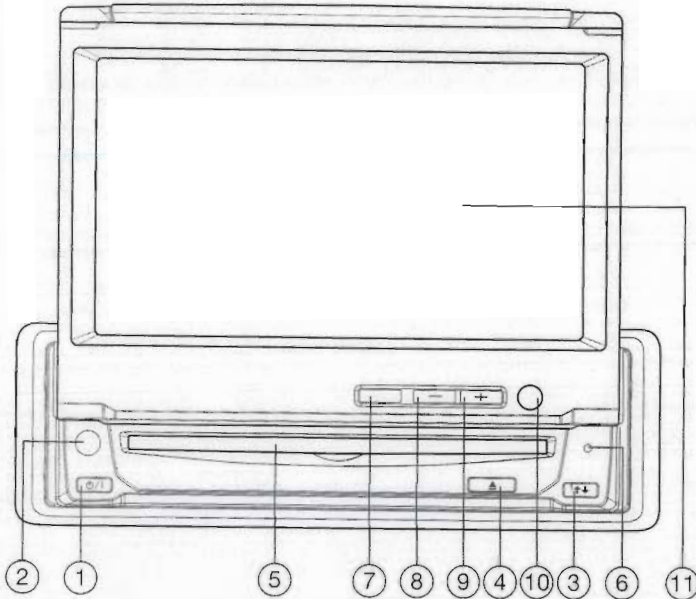

- | | |
|----------------------------|-------------------------------|
| 1. POWER | 7. PICT |
| 2. IR (on the front panel) | 8. - |
| 3. OPEN/CLOSE | 9. + |
| 4. ▲ (EJECT) | 10. IR (on the monitor panel) |
| 5. DISC SLOT | 11. 6.5 INCH COLOR |
| 6. RESET BUTTON | TFT MONITOR |

THE PLAYER

BACK VIEW

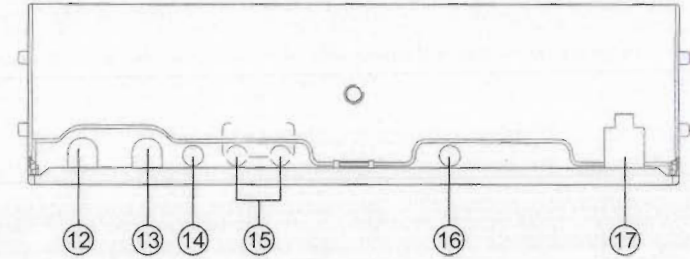

- | | |
|-------------------|------------------------|
| 12. 13-PIN SOCKET | 15. AUDIO/ VIDEO INPUT |
| 13. RGB SYSTEM | 16. DIGITAL AUDIO |
| 14. REMOTE SOCKET | 17. DC 12V IN |

THE TUNER BOX

ONE SIDE

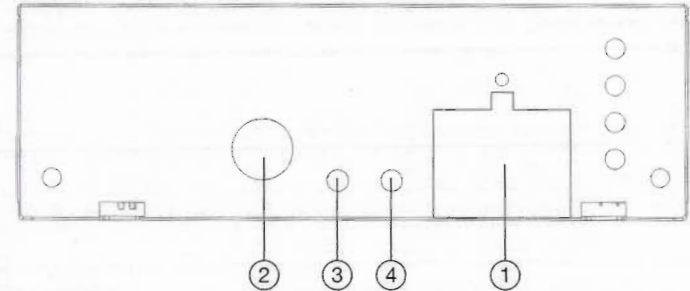

ANOTHER SIDE

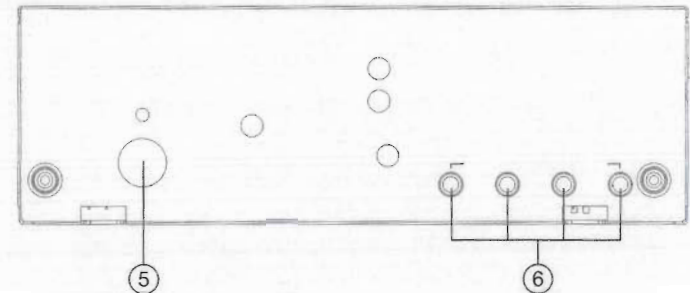

- | | |
|------------------|----------------------|
| 1. 20-PIN SOCKET | 4. AUDIO OUTPUT |
| 2. TO MAIN UNIT | 5. ANTENNA SOCKET |
| 3. VIDEO OUTPUT | 6. DIVERSITY ANTENNA |

ELECTRICAL CONNECTION

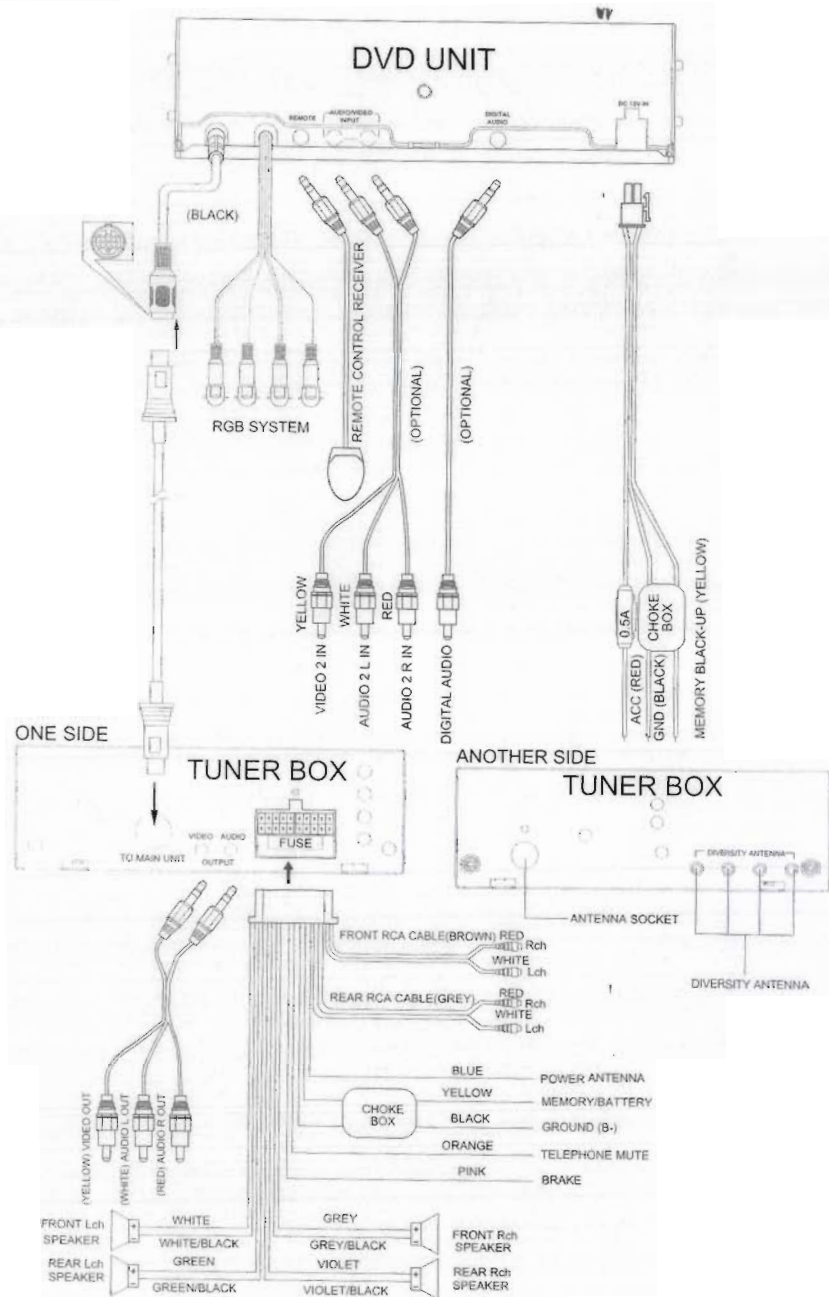

REMOTE CONTROL

LOCATION AND FUNCTION OF KEYS

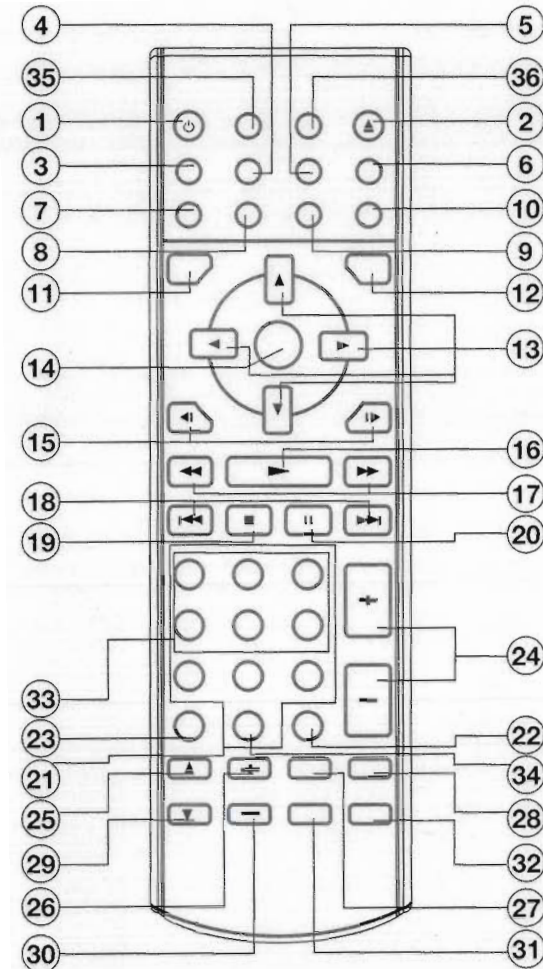

REMOTE CONTROL

1. **POWER** Press **POWER** to turn the unit ON or OFF.
2. **EJECT** When playing a DVD or CD, press to eject the disc.
3. **OPEN/CLOSE** Press to open/close the monitor.
4. **SUBTITLE** Change the SUBTITLE language on multi-subtitle language DVD disc.
5. **ANGLE** Change the view angle on a multi-angle DVD.
6. **DISPLAY** Display statistical disc information during playback in DVD mode.
7. **MODE** Press to change between DVD, RADIO, TV, AV and RGB mode.
8. **SETUP** Display the SETUP menu in DVD mode.
9. **PROGRAM** Plays the tracks in the order you program.
10. **AUDIO** Change the AUDIO Soundtrack on multi-audio soundtrack DVD disc. Change the sound mode of the VCD/CD.
11. **TITLE (DSP)** Display the TITLE menu stored on the DVD.
In TV mode, press to display TV channel on the screen.
12. **MENU** Display the root menu that is stored on the DVD disc.
13. **◀/▶, ▲/▼** In MENU mode, **◀/▶, ▲/▼**, buttons use as cursor buttons to select an item.
14. **ENTER** Confirm the Track/Chapter selected with the numeric buttons or selected with the cursor buttons on screen.
15. **▶ / ◀** Select slow forward/ reverse playback on DVD.
16. **▶** Press to play the disc.
17. **◀◀ / ▶▶** Press **▶▶** to search forward rapidly & **◀◀** to search reverse rapidly.
18. **▶▶ / ◀◀** Press **▶▶** to skip to the next track & press **◀◀** to skip back one track.
19. **■** Press to stop playback.
20. **||** Press to pause playback.
21. **0 - 9** Numeric buttons
22. **10+ (-/-)** Digital selecting button, cooperatively used with numeric buttons.
23. **SEL** In DVD, RADIO, TV, AV mode, press SEL to display the corresponding menu.
24. **PANEL+/-** Press to turn the monitor upward or downward at fine steps.
25. **CH ▲** In radio mode, press **▲** shortly to increase frequency by one step of channel spacing. Hold **▲** for fasting tuning.
In TV mode, press **▲ (CH+)** shortly and release to select the next channel up.
26. **VOL+** Press VOL+ button to increase the volume level.
27. **GOTO (AS/PS) (AUTO)** Disc search button, cooperatively used with numeric buttons.
In radio mode, press for several seconds to enter into automatic memory storing function; press shortly to scan preset station.
In TV mode, press it for several seconds to start search channel automatically, press **▼ (CH-)** to stop it in the course of searching.
28. **PBC** Changing between PBC ON and PBC OFF on the VCD disc.
29. **CH ▼** In radio mode, press **▼** shortly to decrease frequency by one step of channel spacing. Hold **▼** for fasting tuning.
In TV mode, press **▼ (CH-)** shortly to select to select the next channel down.
30. **VOL-** Press VOL- button to decrease the volume level
31. **REPEAT** Switch the Repeat mode of discs.
32. **A-B (MO/ST)** A-B repeat allows a passage to be repeated continuously.
In radio mode, press it to select mono or stereo mode.
33. **RADIO PRESET** Six preset memory buttons.
34. **BAND** In radio mode, press it to select desired band.
35. **MUTE** In radio, DVD, TV or AV mode, press to mute the sound.
36. **ZOOM** Allows the picture to be increased in size.

REMOTE CONTROL

repairing the Remote Control

Inserting the Batteries

1. Open the battery compartment cover.
2. Insert the new batteries. Make sure that the positive and negative terminals of the batteries are oriented as indicated.
3. Close the cover
(Uses two AAA batteries.)

Using the Remote Control

Point the remote control at the remote eye on the unit's front panel.
Operation angle: About ± 30 degree in each the direction of the front of the remote sensor.

LOADING/EJECTING A DISC

Loading a Disc

1. Turn the ignition on the accessory position.
2. Press the **POWER** button (1).
3. Insert the disc with printed side facing up into the disc slot (2).
4. The player starts playback automatically.

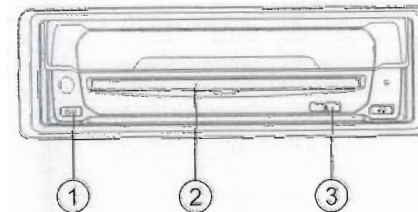

Ejecting a Disc

Only in DVD/CD mode, press **▲** button (3) to eject the disc.

BASIC OPERATION

Turning the player ON/OFF

Press the **POWER** button on the front panel or **(POWER)** button on the remote control to turn the player on or off.

Open/Close the Monitor and Angle Adjustment

- Press **OPEN/CLOSE** button on the front panel or point the remote control to the remote sensor on the front panel and press **OPEN/CLOSE** button on the remote control, the monitor will motor out and flip up automatically.

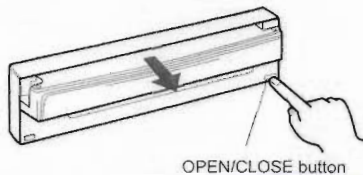

Fig.1

After monitor extends fully it will turn upward and stop when it reaches its vertical position.

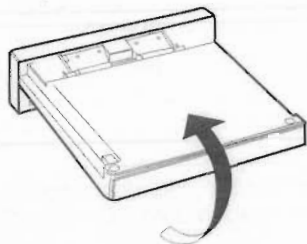

Fig.2

- Adjusting the viewing angle. When the monitor is not in motion, you can press **PANEL+** or **PANEL-** button on the remote control to turn the monitor upward or downward at fine steps to get a desired viewing angle. And you can rotate the monitor left and right from the central viewing position at a certain angle range manually. Don't rotate the monitor forcibly to avoid mechanical damage.

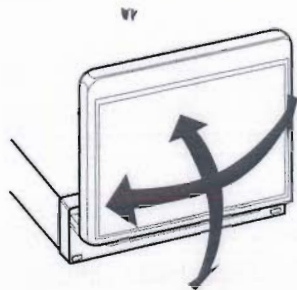

Fig.3

- Return the monitor to the central viewing position, then press **OPEN/CLOSE** button on the front panel or press **OPEN/CLOSE** button on the remote control, the monitor will flip down automatically.

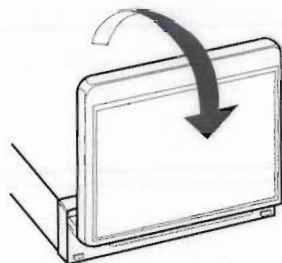

Fig.4

When the monitor is all the way down it will draw into the main chassis.

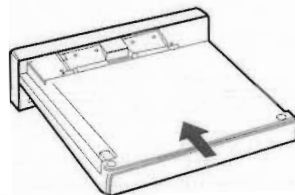

Fig.5

Remote Sensor

There is a remote sensor on the front panel. On the monitor, there is another remote sensor to receive remote control signal. You can point the remote control handset to the remote sensor on the front panel (when the monitor doesn't stretch out) or the remote sensor on the monitor panel (when the monitor stretches out) and press function keys on the remote control to control the DVD unit.

The unit is also connected to an external remote receiver (See the electrical connection diagram above), and the function is the same with the remote sensor on the front panel or on the monitor panel.

Notes:

- Δ Place the external remote receiver (eye) in a location where you can easily point the remote control directly at it.
- Δ When the angle of the remote control is over 30 degrees off axis from the remote eye on the main unit it may be difficult to remotely operate the unit. In this case you should use the external remote receiver.

6.5 Inch TFT Display

When the monitor stretches out, the 6.5 inch color TFT display can show the current state of the unit.

Volume Level Adjustment

Press **VOL +/-** buttons on the remote control to increase or decrease the volume level.

Mode Selection

Press **MODE** button on the remote control to select among DVD, RADIO, TV, AV and RGB mode.

Reset

Reset button is placed on the front panel and must be activated with either a ballpoint pen or thin metal object. The reset button is to be activated for the following reasons:

- Initial installation of the unit when all wiring is completed.
- All the function buttons do not operate.
- Error symbol on the display.

Picture mode Adjustment

Press **PICT** button on the monitor panel, the picture mode will show on the display, repeatedly press **PICT** button to select among **BRIGHT**, **CONTRAST**, **COLOR**, **TINT** (For the unit with NTSC system) and **SCREEN**.

(For the unit with PAL system):

PICTURE	
BRIGHT	32
CONTRAST	32
COLOR	32
SCREEN	16:9

(For the unit with NTSC system):

PICTURE	
BRIGHT	32
CONTRAST	32
COLOR	32
TINT	32
SCREEN	16:9

Press **+/-** buttons on the monitor panel to adjust the selected item. The corresponding value will show on the display.

TELEPHONE MUTE

When you have an incoming call the audio will be muted and "TEL MUTE" appears on the display

BRAKE OFF SAFETY FUNCTION

In most states it is illegal to watch TV or other video entertainment while driving. This unit is equipped with a feature that when installed properly allows video signal only when the emergency (parking) brake is on. When this brake is off the video signal is disabled and the audio signal remains.

DISC (DVD, VCD, CD, MP3) OPERATION

Switching to DVD mode

Press **MODE** button on remote control to select DVD mode.

Stopping Play

- Briefly press the **■** (Stop) button to stop the unit playback, when the **▶** (Play) button is pressed, normal playback will continue.
- Press **■** (Stop) button twice to stop the playback and go back to initial Track/Chapter.

Rapid Forward/Rapid Reverse

Press **▶▶** & **◀◀** during play. Each time the button is pressed, the speed of rapid forward/reverse changes as follows:

DVD:

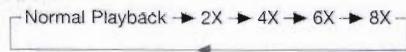

VCD/CD:

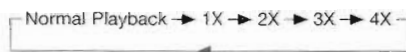

MP3:



Skipping Track

Press **▶▶** / **◀◀** on the remote handset during playback.

Press **▶▶** to skip to next track, and **◀◀** to back one track.

Note: For some VCD2.0 discs (PBC-playback control), **▶▶** / **◀◀** buttons may be unavailable.

Slow Motion Play

Press **▶** / **◀** during play.

Each time the button is pressed, the speed of slow forward/reverse changes as follows:

DVD:

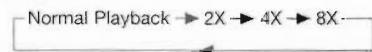

Pause (still picture)

Pressing **⏸** on the remote control during playback will stop play temporary. To return to normal playback, press **▶** on the remote control.

Mute

Will mute the sound, but the disc continues playing. When you unmute the sound (press MUTE again), sound will resume.

Repeat Function

FOR DVD:

Press the **REPEAT** button to select the repeat modes as follows:

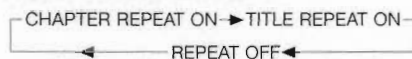

FOR VCD/CD:

Press the **REPEAT** button to select repeat mode as follows:

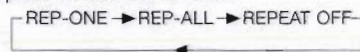

1. REP-ONE: repeats the current chapter/track.
2. REP-ALL: repeats all the chapters/tracks on the current disc.
3. When the player finishes playback of the current disc last chapter/track, it will stop and display the elapsed time. When REPEAT OFF mode is selected, REP-ONE & REP-ALL disappears from screen display.
4. REPEAT feature does not support VCD2.0 (with PBC ON).

A-B

A-B repeat allows a passage to be repeated continuously. Press **A-B** button at the start of the required passage, then press **A-B** button again at the end of the passage. To revert to normal playing, press **A-B** button again. Each time the button is pressed, the screen will display as follows:

A TO B SET A → A TO B SET B → A TO B CANCELLED

Disc Search (GOTO)

FOR DVD

Press **GOTO** button twice, the screen will display the following message:

TITLE 01/01 TIME --:--:--
00:00:25

You can select the item you want to watch through TIME setting by using numeric buttons and ENTER key. FOR CD/VCD (WITH PBC OFF): Press **GOTO** button once, the screen will display the following message:

GOTO --:--
00:00:25

Use numeric buttons to input the time directly.

Zoom

Allows the picture to be increased in size. Press **ZOOM** to toggle among 1.5 scale, 2.0 scale and 3.0 scale.

During Zoom mode, press **◀/▶**, **▲/▼** buttons to move pictures up, down, left of right direction.

Program

For CD/VCD (WITH PBC OFF)/DVD (WITH PBC OFF):

In stop mode, press **PROGRAM** button, the screen will display "PROGRAM P00:00". For example: press numeric button 4, "PROGRAM P01:04" appears. It means track 4 will be played first, then press numeric button 6 and "PROGRAM P02:06" appears. Press the different numeric button to select the corresponding track, and then you can program tracks to your need. If you want to complete program setting, press **▶** button or **ENTER** button to play tracks in programmed order.

For MP3:

In stop mode, press **PROGRAM** button,

the screen will display "PROGRAM P00:0000" the program method is the same as described above. If you want to complete program setting, press **■** (Stop) button first then press **▶** button to play tracks in programmed order. In stop mode, press **PROGRAM** button to exit program mode and "PROGRAM OFF" appears.

If you set WITH MENU in SMART NAV item in PREFERENCE PAGE, you can use **◀/▶**, **▲/▼** buttons to select PROGRAM PXXX mode or track number and press **ENTER** button to confirm it.

Menu Control operation in DVD mode

Press **SEL** button on remote control to enter sound menu, then you can press CH **▲/▼** buttons to select the item upward or downward. Then press **VOL +/-** buttons to adjust the selected item. The corresponding value will show on the display.

VOLUME	40
BASS	2
TREBLE	2
BALANCE	L-R
FADER	F-R
LOUD	ON
EQ	POP



OPERATION

On-Screen Display Function

Press the **DISPLAY** button during playback to display the contents of the current disc on the screen.

Example:

DVD:

(1) Press **DISPLAY** for the first time:

```
TITLE 01/03 CHAPTER 002/025
00:02:25
```

Title Number, Total Title Number, Chapter Number, Total Chapter Number of this Title of the disc currently being played will be shown on the screen, along with the elapsed time.

(2) Press **DISPLAY** for the second time:

```
TITLE REMAIN
01:46:58
```

(3) Press **DISPLAY** for the third time:

```
CHAPTER ELAPSED
00:00:24
```

(4) Press **DISPLAY** for the fourth time:

```
CHAPTER REMAIN
00:01:39
```

(5) Press **DISPLAY** for the fifth time:

The message on the screen will be cleared.

VCD:

(1) Press **DISPLAY** for the first time:

```
SINGLE ELAPSED
00:00:25
```

(2) Press **DISPLAY** for the second time:

```
SINGLE REMAIN
00:03:15
```

(3) Press **DISPLAY** for the third time:

```
TOTAL ELAPSED
00:00:25
```

(4) Press **DISPLAY** for the fourth time:

```
TOTAL REMAIN
00:40:35
```

(5) Press **DISPLAY** for the fifth time:

The message on the screen will be cleared.

CD:

(1) Press **DISPLAY** for the first time:

```
SINGLE ELAPSED
00:00:25
TOTAL TRACK : 14
TRACK : - 01
```

(2) Press **DISPLAY** for the second time:

```
SINGLE REMAIN
00:03:15
TOTAL TRACK : 14
TRACK : - 01
```

(3) Press **DISPLAY** for the third time:

```
TOTAL ELAPSED
00:00:25
TOTAL TRACK : 14
TRACK : - 01
```

OPERATION

(4) Press **DISPLAY** for the fourth time:

```
TOTAL REMAIN
00:40:35
TOTAL TRACK : 14
TRACK : - 01
```

(5) Press **DISPLAY** for the fifth time:

The message on the screen will be cleared.

MP3 (When set to NO MENU in SMART NAV item):

(1) Press **DISPLAY** for the first time:

```
CHAPTER ELAPSED 00:00:25
TOTAL TRACK : 123
TRACK : - 01
```

(2) Press **DISPLAY** for the second time:

```
CHAPTER REMAIN 00:04:25
TOTAL TRACK : 123
TRACK : - 01
```

(3) Press **DISPLAY** for the third time:

The message on the screen will be cleared.

Multi-audio Language Function

For DVD:

Press **AUDIO** on the remote control during playback. Each time the button is pressed, the audio soundtrack changes in sequential order.

Notes:

- The language number is different according to the disc.
- Some discs only contain one language soundtrack.
- When there is no alternate language soundtrack available,  will be displayed at screen left top corner.

For VCD/CD:

Press **AUDIO** during playback. It is possible to switch the sound

between monaural and stereo sound.

MONO LEFT → MONO RIGHT → STEREO

MENU Function (For DVD Only)

Press **MENU** button while the disc is playing and the disc menu will be displayed. You can navigate with the remote control navigation keys and select a feature with the **ENTER** key.

TITLE Menu Function (For DVD only)

If the DVD has multiple titles recorded on the disc. It can select preferred title from the title menu to start playback.

1. Press **TITLE** during playback. The title menu is display.
2. Press the cursor button shown in screen, select preferred title by the cursor button and confirm by **ENTER** key.

Multi-subtitle Language Function (For DVD only)

Press **SUBTITLE** during playback. Each time the button is pressed, the subtitle language changes in sequential order.

Notes:

- The language number is different according to the disc.
- Some discs only contain one subtitle language.
- When no different subtitle language is available,  will be displayed at screen left top corner.

Multi-angle Function (For DVD only)

Press **ANGLE** during playback. Each time the button is pressed, the angle changes in sequential order.

Notes:

- The angle number is different according to the disc.
- The function only works for discs having scenes recorded at different angles.
- When no different angle is available,  will be displayed at screen left top corner.

OPERATION

Smart navigation MP3 Disc Play

MP3 disc is playing as the format of FOLDER.

For example:

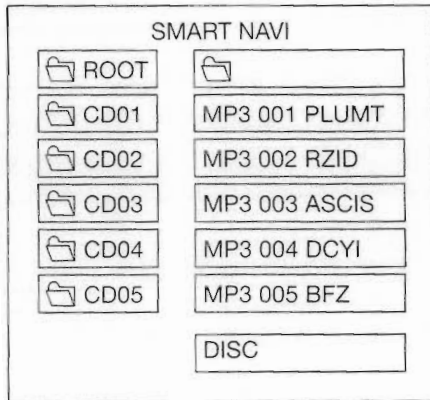

In stop mode, use ▲ / ▼, ◀ / ▶ on the remote control to select the item or folder (such as CD01, CD02...) and press **ENTER** button on the remote control to confirm, then select the desired track (such as 001 PLUMT, 002 RZID...) on the current folder to play.

Pressing **REPEAT** button repeatedly can select three kinds of repeat play mode.

REP-ONE:

Play the same song over and again.

FOLDER REP:

Play all songs in the current directory in sequence, over and again.

FOLDER:

Play all songs in the current directory once.

When select PLAY MODE, press ▲ / ▼ to change between the following mode:

SINGLE → REP-ONE → FOLDER → FOLDER REP →
DISC SCAN → DISC → DISC REP → RANDOM →
SHUFFLE ON → PROGRAM PXXX

During the playback, use ▶▶ or ◀◀ to skip an item ahead or back.

◀◀: Rapid reverse, ▶▶: Rapid advance

Note: The FOLDER cannot be selected during playing. It can be selected after ■ (Stop) button pressed.

RADIO OPERATION

• Switching to radio mode

Press **MODE** button on remote control to select radio mode.

In radio mode, the following information will appear on the display.

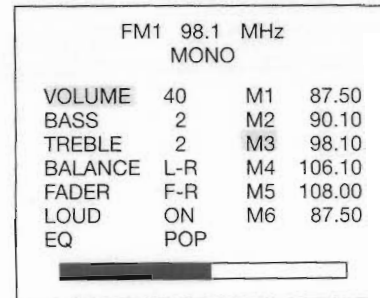

• Selecting the frequency band

Press **BAND** on remote control to select desired band. The reception band will change in the following order:

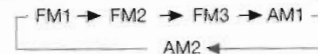

• Selecting station

During radio mode, press **CH ▲** button on remote control to increase frequency or **CH ▼** button on remote control to decrease frequency by one step of channel spacing. Hold the button longer for fast tuning. The frequency is updated correspondingly on display.

• Setting memory

Press **RADIO PRESET** buttons (1~6) on remote control to preset stations at radio mode. With this system, a total of 30 stations can be stored in the memory of six buttons. Each band stores up to six preset stations. The stations might be FM1, FM2, FM3, AM1 and AM2 band. The operation is as below:

- Store in Memory
Press and hold desired memory

OPERATION

location button for several seconds. The current listening station will be stored into the number button.

- Retrieve a Preset Station
Press any one of the **RADIO PRESET** buttons (1~6) on remote control to retrieve a station which had been stored in the memory in advance the chosen number is shown on display.

• Automatic memory storing & program scanning

- Automatic memory storing
Press **GOTO (AS/PS)** button on remote control for several seconds, the radio searches from the current frequency and checks the signal strength until one cycle search is finished. And then 6 strongest stations are stored into the corresponding preset number button.

- Program scanning
Press **GOTO (AS/PS)** button on remote control shortly to scan preset station. When the field strength level is more than the threshold level of stop level. The radio is holding at that preset number for several seconds with release mute, then searches again.

• Mono/stereo

Press **A-B (MO/ST)** button on remote control to select mono or stereo mode. You can sometimes improve reception of distant stations by selecting mono operation.

• Mute

Press **MUTE** button on remote control to cut down sound output. Press it again to resume the previous volume mode. When in the default menu, the "MUTE" will appear on the screen display.

• Menu Control operation in radio mode

When you press **MODE** to select radio mode, the menu appears. Press **SEL** button on remote control to select

VOLUME, then you can press **CH ▲ / ▼** buttons to select the item upward or downward to switch between **VOLUME, BASS, TREBLE, BALANCE, FADER, LOUD** and **EQ** mode. Then press **VOL +/-** buttons to adjust the selected item. The corresponding value will show on the display.

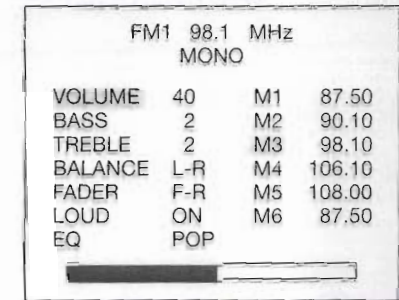

When you select EQ item, there are four audio modes to be selected:



TV OPERATION

• Switching to TV mode

Press **MODE** button on remote control to select TV mode.

• Auto searching TV channels

Press **GOTO (AUTO)** button on remote control to start search channel automatically.

In the course of searching, press **CH ▼** button to stop searching.

• Selecting channel

- Press **CH ▲** button on remote control to choose channel upward and press **CH ▼** button on remote control to choose channel downward.

- The numeric buttons (0,1~9) allow you to select the corresponding channel directly.

- Press digital select button **10+(-/-)** cooperatively used with numeric buttons to select channel desired. For example, when you want select 16 channel, press **10+(-/-)** to switch between "-" and "--", when the "--" appears on the display, you can press

OPERATION

"1" button then press "6" button to select 16 channel.

- Mute**
 Press **MUTE** button on remote control to cut down sound output. Press it again to resume the previous volume mode.
- Screen display**
 Press **TITLE(DSP)** button on remote control to display the current status such as TVch. If you don't operate over five seconds, the information on the screen will disappear.
- Menu Control operation in TV mode**
 Press **SEL** button on remote control to enter sound menu, then you can press **CH ▲ / ▼** buttons to select the item upward or downward. Then press **VOL+/-** buttons to adjust the selected item. The corresponding value will show on the display.

VOLUME	40
BASS	2
TREBLE	2
BALANCE	L-R
FADER	F-R
LOUD	ON
EQ	POP



AV OPERATION

- Switching to AV mode**
 On the back of the unit, there are a pair of AUDIO/VIDEO INPUT jacks. When you connect an audio/video system through these jacks, press **MODE** button on remote control to select AV mode.
- Menu Control operation in AV mode**
 Ppress **SEL** button on remote control to enter sound menu, then press **CH ▲ / ▼** buttons to select the item upward or downward. Then press **VOL+/-** buttons to adjust the selected item. The corresponding value will show on the display.

VOLUME	40
BASS	2
TREBLE	2
BALANCE	L-R
FADER	F-R
LOUD	ON
EQ	POP



- Mute**
 Press **MUTE** button on remote control to cut down sound output. Press it again to resume the previous volume mode.

RGB OPERATION

- Switching to RGB mode**
 When you connect the RGB terminals on the back of the DVD unit to the corresponding RGB system, then press **MODE** button on remote control to select RGB mode, the RGB signal will appear on the screen.

Note: When you press **MODE** button to select RGB mode and there hasn't any RGB signal input, then there is nothing to display on the screen.

SETUP

INITIAL SETUP

SETUP MENU --- MAIN PAGE

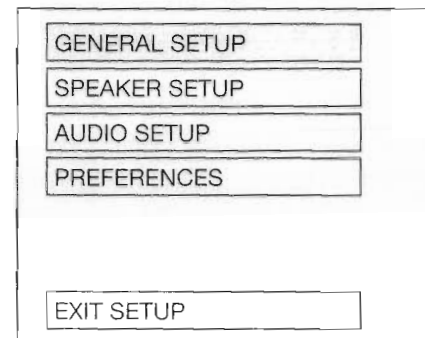

- Press **SETUP** on the remote control in the stop mode. (Press the **■** button twice to ensure that the player is in under STOP mode.)
- The initial SETUP menu is displayed.
- Select the preferred item by using the **▲ / ▼** buttons.
- Press **ENTER** button.
 - GENERAL SETUP**
 This setup page includes all the item of TV display & Audio output feature. For details please refer to **GENERAL SETUP MENU**.
 - SPEAKER SETUP**
 This is to activate the audio output from DOLBY AC3 5.1 DOWNMIX to 2 channel mode. Please refer to **SPEAKER SETUP MENU**.
 - AUDIO SETUP**
 This setup page includes all the items for AUDIO. Please refer to **AUDIO SETUP MENU**.
 - PREFERENCES SETUP**
 This setup page includes all the configuration of support feature. For details please refer to **PREFERENCES SETUP MENU**.

GENERAL SETUP

--- GENERAL PAGE ---

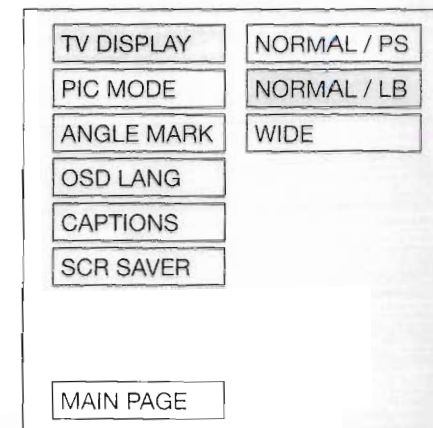

Video Material	TV Screen			
	4:3	Normal	Pan Scan	Letter-box
4:3				
16:9				

TV display setup

This is to select the appropriate TV aspect ratio (4:3 or 16:9) according to the connected TV set.

Normal/PS (For 4:3 TV)

Played back in the PAN & SCAN style. (If connected to wide-screen TV, the left and right edges are cut off.)

Normal/LB (For 4:3 TV)

Played back in letterbox style. (If connected to wide-screen TV, black bands appear at top and bottom of the screen.)

Wide (For 16:9 TV)

Select when a wide-screen TV set is connected.

SETUP

--- GENERAL PAGE ---

TV DISPLAY	
PIC MODE	AUTO
ANGLE MARK	HI-RES
OSD LANG	N-FLICKER
CAPTIONS	
SCR SAVER	
MAIN PAGE	

PIC mode setup

Select AUTO, the player PIC mode will depend on DVD disc.

Select HI-RES format for best image resolution.

Select N-FLICKER format on image or picture with noise or distortion.

--- GENERAL PAGE ---

TV DISPLAY	
PIC MODE	
ANGLE MARK	ON
OSD LANG	OFF
CAPTIONS	
SCR SAVER	
MAIN PAGE	

ANGLE MARK display setup

If it is set to ON, when the multi-angle DVD disc is playing, "∞" (the angle mark) will appear on the screen; if is set to "OFF", the mark will not appear.

--- GENERAL PAGE ---

TV DISPLAY	
PIC MODE	
ANGLE MARK	
OSD LANG	ENGLISH
CAPTIONS	FRENCH
SCR SAVER	GERMAN
	ITALIAN
	SPANISH
MAIN PAGE	

OSD LANG type setup

Select the preferred OSD (On Screen Display) language by using the ▲ / ▼ buttons.

--- GENERAL PAGE ---

TV DISPLAY	
PIC MODE	
ANGLE MARK	
OSD LANG	
CAPTIONS	ON
SCR SAVER	OFF
MAIN PAGE	

CAPTIONS setup

When play DVD disc, activate the CAPTIONS feature by selecting ON and the captions (such as the actor dialogue) appear on the screen; deactivate this feature by selecting OFF and the captions will not appear.

SETUP

--- GENERAL PAGE ---

TV DISPLAY	
PIC MODE	
ANGLE MARK	
OSD LANG	
CAPTIONS	
SCR SAVER	ON
	OFF
MAIN PAGE	

SCR SAVER setup

Select the SCR SAVER ON/OFF.

SPEAKER SETUP

--- SPEAKER SETUP PAGE ---

DOWNMIX	LT/RT
	STEREO
MAIN PAGE	

This is to activate the audio output from DOLBY AC3 5.1 DOWNMIX to 2 channel mode. Select the preferred SPEAKER connection by using the cursor buttons.

- Select the LT/RT to activate the Dolby surround compatible output.
- Select the STEREO to activate simple stereo mode.

AUDIO SETUP

--- AUDIO SETUP ---

AUDIO OUT	ANALOG
OP MODE	SPDIF/RAW
DYNAMIC	SPDIF/PCM
LPCM OUTPUT	
MAIN PAGE	

AUDIO OUT

- Select ANALOG mode to activate analog audio output.

- Select SPDIF/RAW mode to activate raw digital audio output. And the digital audio format depends on the disc record format.

- Select SPDIF/PCM mode to activate PCM digital audio output.

--- AUDIO SETUP ---

AUDIO OUT	
OP MODE	LINE OUT
DYNAMIC	RF REMOD
LPCM OUTPUT	
MAIN PAGE	

OP MODE

- LINE OUT: Line out mode, with digital dialog normalization.

- RF REMOD: RF remodulation mode, with heavy compression and digital dialog normalization.

It is recommended to select LINE OUT mode.

--- AUDIO SETUP ---

AUDIO OUT	
OP MODE	FULL
DYNAMIC	6/8
LPCM OUTPUT	4/8
	2/8
	OFF
MAIN PAGE	

Dynamic Range Control

Select DYNAMIC and adjust the dynamic range of a Dolby Digital encoded program. There are 8 steps between full compression and off compression.

--- AUDIO SETUP ---

AUDIO OUT	
OP MODE	
DYNAMIC	
LPCM OUTPUT	LPCM 48K
	LPCM 96K
MAIN PAGE	

LPCM OUTPUT

Selecting LPCM (Line Pulse Code Modulation) OUTPUT between LPCM 48K and LPCM 96K.

The difference between LPCM 48K and LPCM 96K lies in the sampling frequency. The higher the frequency is, the better the output audio quality is. It is recommended to select LPCM 96K.

PREFERENCES SETUP

--- PREFERENCES PAGE ---

TV TYPE	AUTO
AUDIO	NTSC
SUBTITLE	PAL
DISC MENU	
PARENTAL	
PASSWORD	
DEFAULTS	
SMART NAV	
MAIN PAGE	

TV type setup

This player can play discs recorded in either PAL or NTSC format.

Select NTSC format, when the unit is connected to NTSC TV.

Select PAL format, when the unit is connected to PAL TV.

Select AUTO format, the player TV output format will be according to the DVD disc format.

--- PREFERENCES PAGE ---

TV TYPE	
AUDIO	ENGLISH
SUBTITLE	FRENCH
DISC MENU	SPANISH
PARENTAL	CHINESE
PASSWORD	JAPANESE
DEFAULTS	GERMAN
SMART NAV	ITALIAN
MAIN PAGE	

AUDIO language setup

Select the preferred AUDIO soundtrack by using the cursor buttons.

--- PREFERENCES PAGE ---

TV TYPE	
AUDIO	ENGLISH
SUBTITLE	FRENCH
DISC MENU	SPANISH
PARENTAL	CHINESE
PASSWORD	JAPANESE
DEFAULTS	GERMAN
SMART NAV	ITALIAN
MAIN PAGE	

SUBTITLE language setup

Select the preferred SUBTITLE language by using the cursor buttons.

--- PREFERENCES PAGE ---

TV TYPE	
AUDIO	
SUBTITLE	ENGLISH
DISC MENU	FRENCH
PARENTAL	SPANISH
PASSWORD	CHINESE
DEFAULTS	JAPANESE
SMART NAV	GERMAN
MAIN PAGE	

DISC MENU language setup

Select the preferred DISC MENU language by using the cursor buttons.

--- PREFERENCES PAGE ---

TV TYPE	1 G
AUDIO	2
SUBTITLE	3 PG
DISC MENU	4 PG 13
PARENTAL	5
PASSWORD	6 PG-R
DEFAULTS	7 NC-17
SMART NAV	8 ADULT
MAIN PAGE	

PARENTAL

Select suitable parental guidance by the cursor buttons and confirm by pressing ENTER button.

--- PREFERENCES PAGE ---

TV TYPE	
AUDIO	
SUBTITLE	
DISC MENU	
PARENTAL	
PASSWORD	CHANGE
DEFAULTS	
SMART NAV	
MAIN PAGE	

PASSWORD

Select the change and press ENTER button. Type the old password (The initial factory code is 3308) and key in 4 characters password now you want to use, and retype again to confirm key in correctly.

SETUP

--- PREFERENCES PAGE ---

TV TYPE
AUDIO
SUBTITLE
DISC MENU
PARENTAL
PASSWORD
DEFAULTS
SMART NAV
MAIN PAGE

RESET

DEFAULTS

Select reset to revert to factory initial settings.

--- PREFERENCES PAGE ---

TV TYPE
AUDIO
SUBTITLE
DISC MENU
PARENTAL
PASSWORD
DEFAULTS
SMART NAV
MAIN PAGE

NO MENU
WITH MENU

SMART NAV

If select WITH MENU, when play a MP3 disc, the smart navigation menu will appear on the screen, then the user can select a track to play according to the menu hint. If select NO MENU, when play a MP3 disc, there is no menu to display and it starts to play directly. The user can adjust this item according to one's need.

DEFAULTS TABLE

General Setup	TV Display	Normal/LB
	PIC Mode	AUTO
	Angle Mark	ON
	OSD Language	English
	Captions	ON
	SCR Saver	ON
Speaker Setup	Downmix	Stereo
Audio Setup	Audio Out	SPDIF/RAW
	OP Mode	Line Out
	Dynamic	FULL
	LPCM Output	LPCM 96K
Preferences	TV Type	AUTO
	Audio	English
	Subtitle	English
	DISC Menu	English
	Parental	NO_Parental
	Password	3308
	Smart NAV	With Menu

TROUBLE SHOOTING

If it appears that your DVD unit is faulty, first consult this checklist. It may be that something simple has been overlooked.

Under no circumstances should you try to repair the player yourself, as this will invalidate the warranty. Only qualified service personnel can remove the cover or service this player.

NO POWER

- Check if the on/off button on the front of the player is set to on.
- Check the DC voltage on the power plug of the main unit.

NO PICTURE

- Make sure you have selected the proper mode (i.e. DVD, TV, etc.)
- Check the video connections.

DISTORTED PICTURE

- Check the disc for fingerprints and clean with soft cloth, wiping from centre to edge.
- Sometimes a small amount of picture distortion may appear. This is not a malfunction.

THE PICTURE IS TOO DARK, TOO BRIGHT, OR HAS NO COLOR

- Press PICT button on the monitor panel, then press + button - button to increase or decrease the level of the corresponding item (BRIGHT, CONTRAST, COLOR or TINT) and adjust to your desired picture quality.

COMPLETELY DISTORTED PICTURE

- Make sure your disc is the same format as your monitor (NTSC/PAL)

NO COLOR IN PICTURE

- Make sure your disc is the same format as your monitor (NTSC/PAL)

DISC DOES NOT PLAY

- Ensure the disc label is upwards.
- Clean the disc.
- Check if the disc is defective by trying another disc.

NO SOUND

- Check audio connections.
- If using a HIFI amplifier, try another sound source.
- Check if the volume is minimum, and adjust the VOL+ to increase the volume

level.

DISTORTED AUDIO FROM AMPLIFIER

- Make sure the gain controls on the amp are set below distortion level.

NO RETURN TO START-UP SCREEN WHEN DISC IS REMOVED

- Press POWER to turn off the unit, then press it again to turn on the unit.
- Press reset button on the front of the DVD unit.

THE PLAYER DOES NOT RESPOND TO THE REMOTE CONTROL

- Aim the remote control directly at the sensor on the front of the player.
- Avoid all obstacles which may interfere with the signal path.
- Inspect or replace the remote control batteries.

DISTORTED OR BLACK & WHITE PICTURE

- Make sure your disc is the same format as your monitor (NTSC/PAL)

NO AUDIO AT DIGITAL OUTPUT

- Check the digital connections.
- Check the Digital Audio menu to make sure that the digital output is correctly set.
- Check if the audio format of the selected audio language matches your receiver's capabilities.

CAN'T RECEIVE TV SIGNAL OR THE PICTURE QUALITY IS POOR IN TV MODE

- Please confirm the antenna is connected to the antenna socket of the TUNER BOX.
- The TV signal at your location may be too weak to lock in a picture. You may have no signal at all.

BUTTONS DO NOT WORK

- Turn the player off and on with the power on/off button on the front of the player.
- Press Reset button on the front of the DVD unit.

SPECIFICATIONS

GENERAL

Power Supply Requirements : DC 12 Volts, Negative Ground
Maximum Output Power : 80 watts x 4 Channels
Current Consumption : 15 Amperes (max.)

TV

TV Sensitivity : 45dB μ V @CH25 in average

RADIO

FM

Frequency Coverage : 87.5 to 107.9 MHz
Sensitivity (S/N=30dB) : 4 μ V
Image Rejection : >45dB
Stereo Separation : >25dB
RD PSG : <38dB

AM

Frequency Coverage : 520 to 1710 kHz
Sensitivity (S/N=20dB) : 36 dBu
Image Rejection : 45 dB

SPECIFICATIONS

DVD

Supply voltage : 12V DC (11V-15V), test voltage 14.4V, negative ground
Current consumption : Less than 3A
Signal system : Compositive video 1.0Vp-p 75 Ω
Discs played : (1) DVD-VIDEO disc
5" (12 cm) single-sided, single-layer
5" (12 cm) single-sided, double-layer
(2) Compact disc (CD-DA/CD-R/CD-RW/MP3)
(3) 5" (12 cm) Video CD
Monitor Screen Size : 6.5" TFT
Resolution : 1200x234 pixels
Brightness : 600 NITS

Note:

Specifications and design are subject to modification, without notice, due to improvements in technology.

This product incorporates copyright protection technology that is protected by method claims of certain U.S. patents and other intellectual property rights owned by Macrovision Corporation and other rights owners. Use of this copyright protection technology must be authorized by Macrovision Corporation, and is intended for home and other limited viewing uses only unless otherwise authorized by Macrovision Corporation. Reverse engineering or disassembly is prohibited.