

SOUND STORM
LABORATORIES
MOBILE ENTERTAINMENT SYSTEM



User's Manual

SDVD350MT

FEATURES

Compatible with PAL DVD (Video CD) and NTSC DVD (Video CD)

This player can play discs recorded in either PAL or NTSC format.

- A single LSI chip now integrates all major DVD playback circuit functions including MPEG2 decoder, video D/A converter, and audio decoders.

- L/R stereo analog audio outputs for connection to existing head unit aux inputs. Video output is composite video.

- Supplied remote handles multi-function software (multi-language audio-track/subtitle, multi-angle, multi-story, etc.); plus all basic functions.

USE THIS PRODUCT SAFELY

When Driving

Keep the volume level low enough to be aware of road and traffic conditions.

When Washing Your Car

Do not expose the product to water or excessive moisture. This could cause electrical shorts, fire or other damage.

When Parked

Parking in direct sunlight can produce very high temperatures inside your vehicle. Give the interior a chance to cool down before starting playback.

Use the Proper Power Supply

This product is designed to operate with a 12 volt DC, negative ground battery system (the regular system in a North American car).

Protect the Disc Mechanism

Avoid inserting any foreign objects into the slot of this player.

Failure to observe this may cause malfunction due to the precise mechanism of this unit.

Use Authorized Service Centres

Do not attempt to disassemble or adjust this precision product. Please refer to the Service Centre list included with this product for service assistance.

For Installation

The unit should be installed in a horizontal position with the front end up at a convenient angle, but not more than 30°.

CONTENTS

Safety Information	4
Disc Notes	5
The Player	7
Installation	8
Replacing the Dome Light Blub	9
Electric Connections	10
Remote Control	11
Location and Function of Keys	12
Preparing the Remote Control	13
Loading/Ejecting a disc	13
Loading a Disc	13
Ejecting a Disc	13
Operation	14
Basic Play	14
Menu Function	16
On-Screen Display Function	16
Multi-audio Language Function	17
Title Menu Function	18
Subtitle Language Function	18
Multi-angle Function	18
MP3 Disc Play	18
Setup	19
Initial Setup	19
General Setup	19
Speaker Setup	21
Audio Setup	21
Preferences Setup	22
Defaults Table	24
Trouble Shooting	25
Specifications	26

SAFETY INFORMATION

CAUTION:

MOBILE DVD PLAYER IS A CLASS I LASER PRODUCT. HOWEVER THIS MOBILE DVD PLAYER USES A VISIBLE/INVISIBLE LASER BEAM WHICH COULD CAUSE HAZARDOUS RADIATION EXPOSURE IF DIRECTED. BE SURE TO OPERATE THE MOBILE DVD PLAYER CORRECTLY AS INSTRUCTED.

USE OF CONTROLS OR ADJUSTMENTS OR PERFORMANCE OF PROCEDURES OTHER THAN THOSE SPECIFIED HEREIN MAY RESULT IN HAZARDOUS RADIATION EXPOSURE.

DO NOT OPEN COVERS AND - DO NOT REPAIR YOURSELF. REFER SERVICING TO QUALIFIED PERSONNEL.

WARNING:

- TO REDUCE THE RISK OF FIRE OR ELECTRIC SHOCK, DO NOT EXPOSE THIS EQUIPMENT TO RAIN OR MOISTURE.
- TO REDUCE THE RISK OF FIRE OR ELECTRIC SHOCK, AND ANNOYING INTERFERENCE, USE ONLY THE RECOMMENDED ACCESSORIES.
- THIS DEVICE IS INTENDED FOR CONTINUOUS OPERATION.

This product incorporates copyright protection technology that is protected by method claims of certain U.S. patents and other intellectual property rights owned by Macrovision Corporation and other rights owners. Use of this copyright protection technology must be authorized by Macrovision Corporation, and is intended personal and other limited viewing unless authorized by Macrovision Corporation.

Region Management Information

Region Management Information:
This Mobile DVD Player is designed and manufactured to respond to the Region Management Information that is recorded on a DVD disc. If the Region number described on the DVD disc does not correspond to the Region number of this Mobile DVD Player, this Mobile DVD Player cannot play this disc.

DISC NOTES

Disc formats supported by this player



DVD
12 cm disc
(Single-sided disc only)



Video CD
12 cm disc



CD
12 cm disc



MP3
12 cm disc

Discs which cannot be played with this player

- DVD-ROM
- DVD-R/DVD-RAM
- CDV
- CD-G

Handling and Cleaning

- Dirt, dust, scratches and warping disc will cause misoperation.
- Do not place stickers or make scratches on discs.
- Do not warp discs.
- When not in use a disc should always be kept in its case to prevent damage.
- Do not place discs in the following places:
 1. Direct sunlight
 2. Dirty, dusty and damp areas
 3. Near car heaters
 4. On the seats or dashboard

Disc Cleaning

Use a dry soft cloth to wipe the surface. If the disc is quite dirty, use a soft cloth slightly moistured with isopropyl (rubbing) alcohol. Never use solvents such as benzene, thinner or conventional record cleaners as they may mar the surface of the disc.

Note:

A disc may become somewhat scratched (although not enough to make it unusable) depending on your handling of it and the surrounding environment.

Note these scratches are not an indication of any problem with the player.

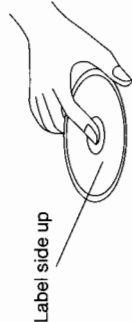

Label side up

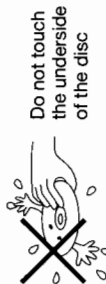

Do not touch the underside of the disc



Do not bend



Wipe the disc from center toward the outside edge

Preparing New Discs

A new disc may have rough spots on the inner and outer edges. A disc with these rough spots or burrs may not play properly or at all. These rough spots can be removed using a pencil or ballpoint pen as shown below. Rub the side of the pen or pencil on the inner and outer edges of the disc. Be very careful not to touch the top or bottom disc surface with the pen or pencil.

Rough spots on outside edge

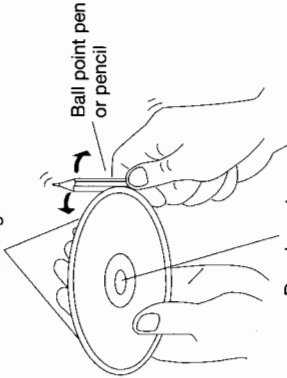

Rough spots on inside edge

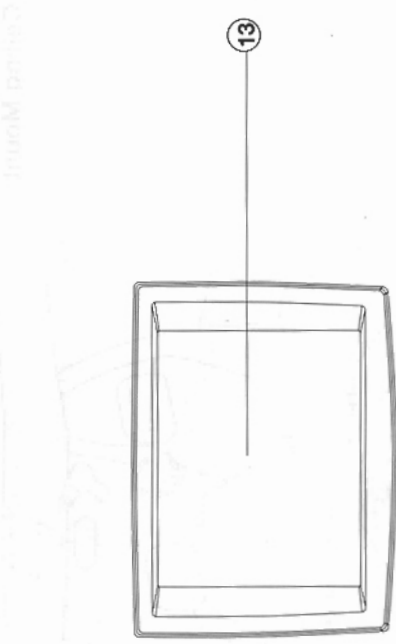
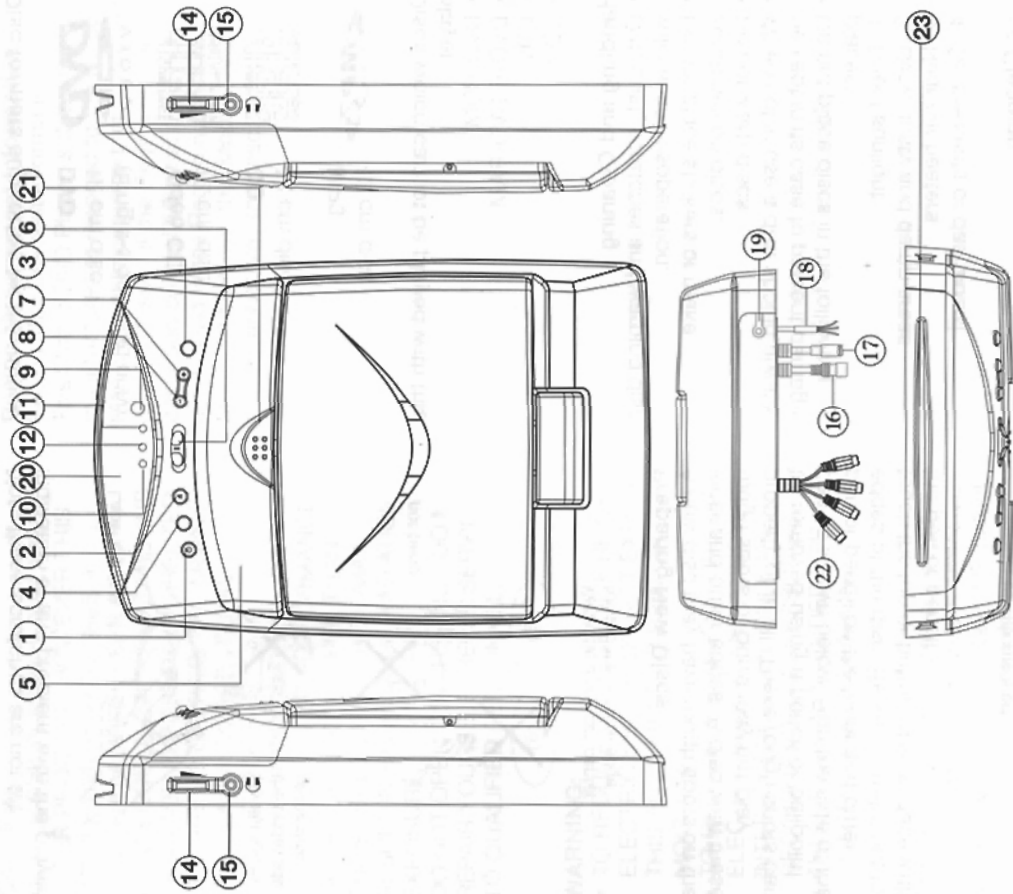

FIG.A 7 INCH WIDESCREEN TFT COLOR MONITOR

1. POWER (⏻)
2. EJECT (▲)
3. MENU
4. Mode
5. Dome Light
6. Light Switch
7. VOLUME +
8. VOLUME -
9. IR
10. Indicator Light for DVD
11. Indicator Light for AV
12. Indicator Light for TV

13. 7-inch Widescreen TFT Color Monitor
14. Earphone volume control knob
15. Jacks for Earphone
16. AV IN
17. AV OUT
18. Wires for power supply and dome light
19. DIGITAL AUDIO
20. INFRARED TRANSMITTING WINDOW
21. Open button: Press to release the screen from its stored position
22. Diversity Antenna
23. Disc Slot

INSTALLATION

Mounting

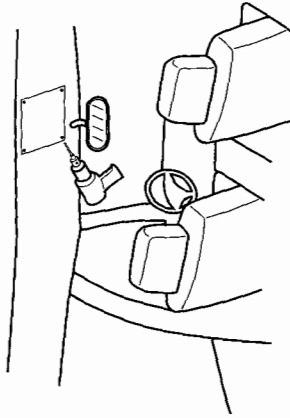

Fig. 1

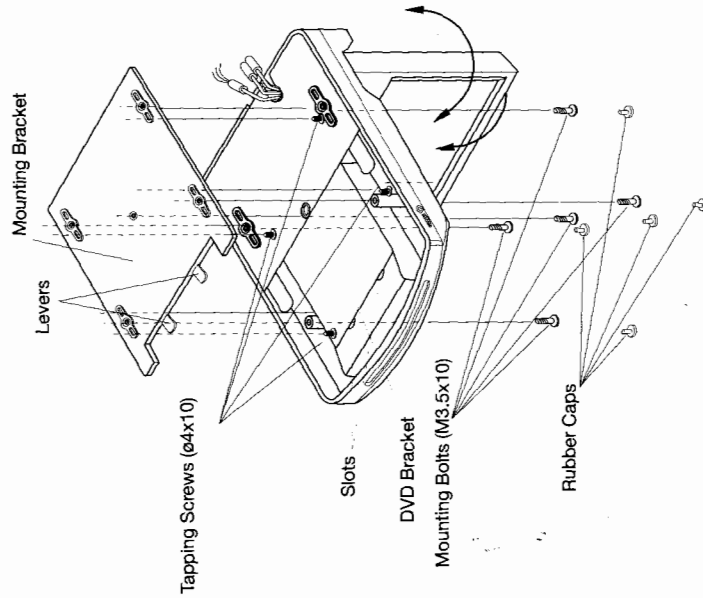
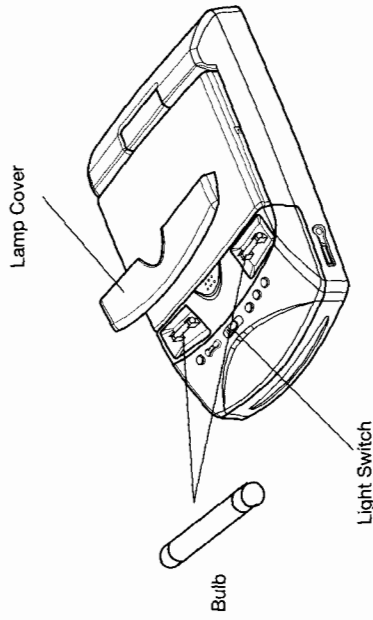

Fig. 2

1. Determine the mounting location and drill four mounting holes (See Fig.1).
 2. Attach the mounting bracket to the holes with the tapping screws (ø4x10).
 3. Align two levers with the slots in the DVD bracket to fix attached the unit.
 4. Open the monitor to display the five screw holes.
 5. Attach the unit to the bracket with the mounting bolts (M 3.5x10).
 6. Insert five rubber caps to the screw holes.
 7. When the installation is completed, you can turn the display upward or downward, left or right to adjust the viewing angle. (See the arrowhead symbol in Fig.2).
- CAUTION: When drilling holes be careful not to drill through the roof of the vehicle.**

REPLACING THE DOME LIGHT BULB

1. Press the open button to release the screen.
2. Put the light switch in the OFF position.
3. Push back the lamp cover and open it. (Refer to the following figure)
4. Remove and discard the old bulb.
5. Install a new bulb.
6. Close the cover.



Bulb Specification
Diameter: ø8mm
Length: 28mm
Voltage Spec.: DC12V, 5W

ELECTRIC CONNECTION

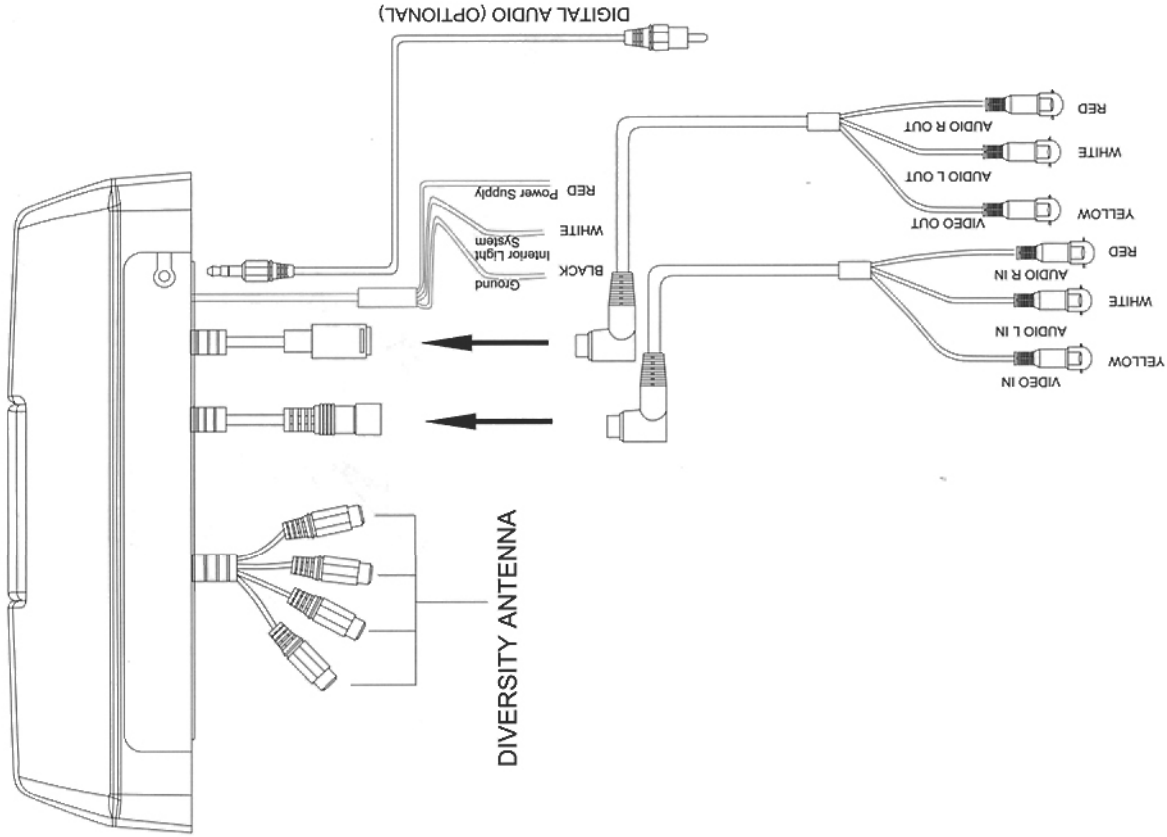

REMOTE CONTROL

LOCATION AND FUNCTION OF KEYS

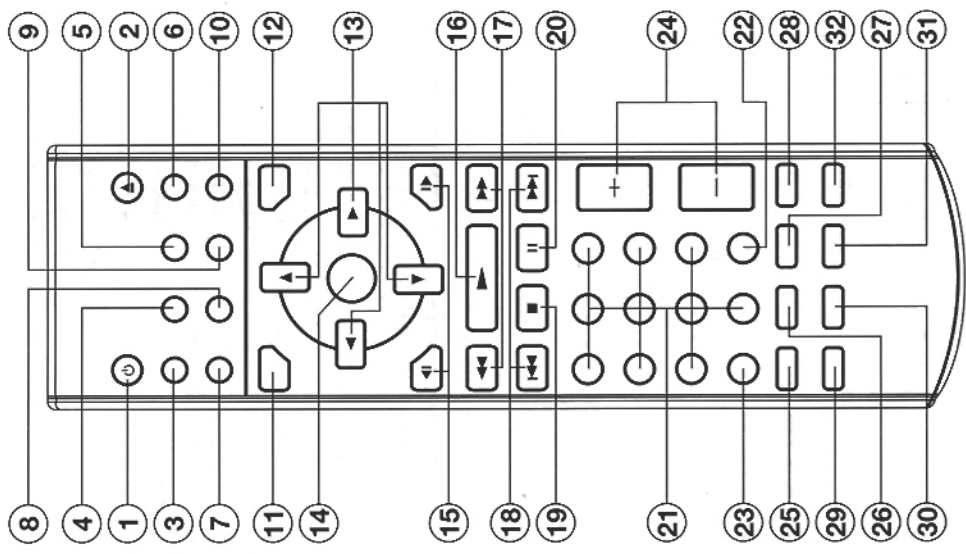

REMOTE CONTROL

1. **POWER**
Press **POWER** to turn the unit **ON** or **OFF**.
2. **EJECT**
Press to eject the disc.
3. **MUTE**
Press to mute the sound.
4. **SUBTITLE**
Changes of the **SUBTITLE** language on multi-subtitle language DVD disc.
Changing of the view angle on multi-angle DVD disc.
5. **ANGLE**
Display statistical disc information during playback.
6. **DISPLAY**
Choose between DVD mode, AV mode and TV mode.
7. **MODE**
Display the **SETUP** menu.
8. **SETUP**
Switch between PAL mode and NTSC mode in DVD mode.
9. **PAL/NTSC**
Changes of the **AUDIO** soundtrack on multi-audio soundtrack DVD disc. Changing of the sound mode of the VCD/CD disc.
10. **AUDIO**
Display the **TITLE** menu that is stored in DVD disc.
11. **TITLE**
Display the adjustment items, such as Bright, Contrast, Color, Tint, Transmit, Screen and etc.
12. **MENU**
In **SETUP** menu mode, these served as cursor buttons to select item left, right, up and down.
13. **◀/▶, ▲/▼**
Confirm the **Track/Chapter** selected with the numeric buttons or selected with the cursor buttons on screen display.
Select slow forward/reverse playback.
14. **ENTER**
Press to play the disc.
15. **▶/◀**
Press **▶▶** to start forward rapidly & **◀◀** to reverse rapidly.
16. **▶**
Press **▶▶▶** to skip to the next track & press **◀◀◀** to skip back one track.
17. **◀◀/▶▶**
Press it to stop playback.
18. **▶▶▶/◀◀◀**
Press it to pause playback.
19. **■**
Numeric buttons
20. **||**
Digital selecting button, cooperatively used with numeric buttons.
21. **0 - 9**
When you input a number in error, press the button to clear it.
22. **10+**
Press **VOLUME+/-** button to increase or decrease the volume level.
23. **CLEAR**
Adjust the selected item in the menu.
24. **VOLUME+/-**
Allows the picture to be increased in size.
25. **ZOOM**
When in stop mode, press the button, then play can be resumed from the stop point.
26. **RESUME**
Disc search button, cooperatively used with numeric buttons.
27. **GOTO**
Changing between **PBC ON** and **PBC OFF** on the VCD disc.
28. **PBC**
Plays the tracks in random order.
29. **RANDOM**
Plays the tracks in the order you program them.
30. **PROGRAM**
Switch the Repeat mode of discs.
31. **REPEAT**
A-B repeat allows a passage to be repeated continuously.
32. **A-B**

REMOTE CONTROL

Preparing the Remote Control

Inserting the Batteries

1. Open the battery compartment cover.
2. Insert the new batteries. Make sure that the positive and negative terminals of the batteries are oriented as indicated.
3. Close cover
Battery: Two AAA size battery.

Using the Remote Control

Point the remote control toward the front panel of the DVD player at the remote (eye) receiver.
Operation Angle: ± 30 degree in each direction off direct axis to the remote receiver.

LOADING/EJECTING A DISC

Loading a Disc

When installation has been completed, you may load a disc as follows:

1. Turn the ignition to the Accessory (ACC) position.
2. Press the **POWER** button (1).
3. Insert the disc with printed side facing up into the disc slot (2).
4. The player starts playback automatically.

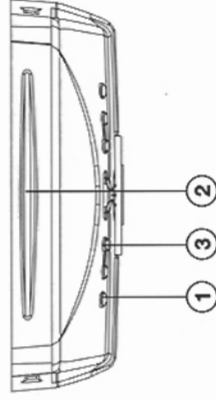

Ejecting a Disc

Press **▲ (EJECT)** button (3) to eject the disc.

OPERATION

BASIC PLAY

STOPPING PLAY

- Briefly press the **■** (Stop) button to stop the unit playback, when the **▶** (Play) button is pressed, normal playback will continue.
- Press **■** (Stop) button twice to stop the playback and go back to initial Track/Chapter.

RAPID FORWARD/RAPID REVERSE

Press **▶▶** & **◀◀** during play. Each time the button is pressed, the speed of rapid forward/reverse changes according to the disc as follow.

DVD:

VCD/CD:

MP3:

SKIPPING TRACK

Press **▶▶** / **◀◀** buttons on the remote handset or on the front panel during playback.
Press **▶▶** to skip to next track, and **◀◀** to back one track.
Note: For some VCD 2.0 discs (PBC-playback control), **▶▶** / **◀◀** buttons may be unavailable.

SLOW MOTION PLAY

Press **⏪** / **⏩** during play.
Each time the button is pressed, the speed of slow forward/reverse changes according to the disc as follow.

DVD:

PAUSE

Pressing **⏸** on the remote control during playback will stop play temporary. To return to normal playback, press **▶** on the remote control.

MUTE

Will mute the sound, but the disc continues playing. When you unmute the sound (press **MUTE** again), sound will resume.

REPEAT

FOR DVD:
Press the **REPEAT** button to select repeat mode as follow.



FOR VCD/CD:
Press the **REPEAT** button to select repeat mode as follow.



- Continuously repeat at the current chapter/track, when selected **REP-ONE** mode.
- Select **REP-ALL** mode to continuously repeat all chapter/track on the current disc.
- When the player finishes playback of the current disc last chapter/track, it will stop and display the elapsed time. When **REPEAT OFF** mode is selected, **REP-ONE & REP-ALL** disappears from screen display.
- REPEAT** feature does not support VCD2.0 (with PBC ON).

A-B

A-B repeat allows a passage to be repeated continuously. Press **A-B** button at the start of the required passage, then press **A-B** button again at the end of the passage. To revert to normal playing, press **A-B** button again. Each time the button is pressed, the screen will display as follows:

DISC SEARCH (GOTO)

FOR DVD
Press **GOTO** button twice, the screen will display the following message:

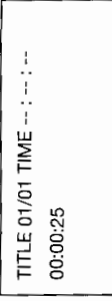

You can select the item you want to watch through **TIME** setting by using numeric buttons and **ENTER** key.

FOR VCD (WITH PBC OFF)/CD:
Press **GOTO** button once, the screen will display the following message:

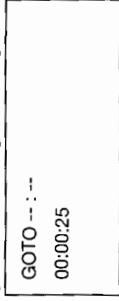

Use numeric buttons to input the time directly.

ZOOM

Allows the picture to be increased in size. Press **ZOOM** to toggle among 1.5 scale, 2.0 scale and 3.0 scale.

RANDOM

Press **RANDOM** button, track selection will be made in random order. The display screen will show "SHUFFLE ON" on the right-top corner. Press **RANDOM** button again, "SHUFFLE OFF" appears and release the mode.

PROGRAM

In stop mode, press **PROGRAM** button, the screen will display "PROGRAM P00:00". For example: press numeric button 4 and **▶** button, "PROGRAM P01:04" appears. It means track 4 will be played first.

MODE SELECTION

Press **MOD** button on the front panel of the unit or **MODE** button on the remote control to select between DVD AV and TV mode. The corresponding indicator will illuminate on the front panel.

VOLUME LEVEL ADJUSTMENT

Press **VOL +/VOL -** on the front panel or **VOLUME +/-** on the remote control to increase or decrease the volume level.

LIGHT SWITCH

The two car dome lamps on the unit will be on in some needed situations. There are three settings for the car dome lamp operation: **OFF**, **AUTO**, and **ON**, refer to the light switch.

- A. **OFF**: To turn off the lamp.
- B. **AUTO**: To make the lamp turn on only when car doors are opened.
- C. **ON**: To turn on the lamp.

JACK FOR EARPHONE (Ⓜ)

There are two jacks for earphone. You can connect an earphone to anyone of the jacks to receive sound signal.

EARPHONE VOLUME ADJUSTMENT

Slide the knob on the side of the DVD unit to increase or decrease the volume level of the earphone.

REMOTE SENSOR (IR)

Point the remote handset to the remote sensor **IR** on the front panel. Receive the signal from remote handset.

TURNING THE UNIT ON/OFF

Press the **⏻** (**POWER**) button on the front panel or on the remote control to turn the unit on or off.

Monitor Release

INFRARED TRANSMITTING WINDOW

There are six infrared transmitting lights inside the window on the unit, the user can put on the infrared wireless headphones supplied with the unit and hear the sound signal emitting from the window.

OPERATION

MENU FUNCTION

Press the **MENU** button on the unit or on the remote control during DVD, AV mode to display the adjustment items on the screen.

MENU	
BRIGHT	20
CONTRAST	25
COLOR	45
TINT	10
TRANSMIT	ON
SCREEN	16:9
- - - - - ■ - - - - -	

Repeatedly press **MENU** button to select among **BRIGHT**, **CONTRAST**, **COLOR** and **TINT** (For the unit with NTSC system) items and etc. Press **VOL +/-** buttons on the unit or **VOLUME +/-** buttons on the remote control to adjust the corresponding item.

Note: When you set the TV TYPE item to "PAL" in "PREFERENCES SETUP", there is no "TINT" item to display. The **TRANSMIT** item is effective when the unit has the infrared transmitting function. In **TRANSMIT** item, there is ON or OFF to be selected. When set it to ON, the sound signal can be emitted from the infrared transmitting window on the unit and you can use the infrared wireless headphone to hear the sound signal. In **SCREEN** item, you can select appropriate TV aspect (4:3 or 16:9) using the **VOL +/-VOL-** buttons on the unit or **VOLUME +/-** buttons on the remote control.

ON-SCREEN DISPLAY FUNCTION

Press the **DISPLAY** button during playback to display the contents of the current disc on the screen.
Example:

DVD:

(1) Press **DISPLAY** for the first time:

TITLE 01/03 CHAPTER 002/025
00:02:25

Title Number, Total Title Number, Chapter Number, Total Chapter Number of this Title of the disc currently being played will be shown on the screen, along with the elapsed time.

(2) Press **DISPLAY** for the second time:

TITLE REMAIN
01:46:58

(3) Press **DISPLAY** for the third time:

CHAPTER ELAPSED
00:00:24

(4) Press **DISPLAY** for the fourth time:

CHAPTER REMAIN
00:01:39

(5) Press **DISPLAY** for the fifth time:

The message on the screen will be cleared.

VCD:

(1) Press **DISPLAY** for the first time:

SINGLE ELAPSED
00:00:25

OPERATION

(2) Press **DISPLAY** for the second time:

SINGLE REMAIN
00:03:15

(3) Press **DISPLAY** for the third time:

TOTAL ELAPSED
00:00:25

(4) Press **DISPLAY** for the fourth time:

TOTAL REMAIN
00:40:35

(5) Press **DISPLAY** for the fifth time:

The message on the screen will be cleared.

CD:

(1) Press **DISPLAY** for the first time:

SINGLE ELAPSED
00:00:25
TRACK : 01/14

(2) Press **DISPLAY** for the second time:

SINGLE REMAIN
00:03:15
TRACK : 01/14

(3) Press **DISPLAY** for the third time:

TOTAL ELAPSED
00:00:25
TRACK : 01/14

(4) Press **DISPLAY** for the fourth time:

TOTAL REMAIN
00:40:35
TRACK : 01/14

(5) Press **DISPLAY** for the fifth time:
The message on the screen will be cleared.

MP3 (When set to NO MENU in SMART NAV item):

(1) Press **DISPLAY** for the first time:

CHAPTER ELAPSED 00:00:25
TRACK : 01/123

(2) Press **DISPLAY** for the second time:

CHAPTER REMAIN 00:04:25
TRACK : 01/123

(3) Press **DISPLAY** for the third time:
The message on the screen will be cleared.

MULTI-AUDIO LANGUAGE FUNCTION

For DVD:

Press **AUDIO** during playback. Each time the button is pressed, the audio soundtrack language changes on sequential order.

Notes:

- The language number is different according to the disc.
- Some disc only contain one language soundtrack.
- When no different language soundtrack are recorded, will be displayed at screen left top corner.

For VCD/CD:

Press **AUDIO** during playback. It is possible to switch the sound between monaural and stereo sound.

OPERATION

TITLE MENU FUNCTION (FOR DVD ONLY)

If the DVD has multiple titles recorded on the disc, it can select preferred title from the title menu to start playback.

- Press **TITLE** during playback.
- The title menu is display.
- Press the cursor button shown in screen display, select preferred title by the cursor button and confirm by ENTER key.

MULTI-SUBTITLE LANGUAGE FUNCTION (FOR DVD ONLY)

Press **SUBTITLE** during playback. Each time the button is pressed, the subtitle language changes in sequential order.

- Notes:
- The language number is different according to the disc.
 - Some discs only contain one subtitle language.
 - When no different subtitle language are recorded, will be displayed at screen left top corner.

MULTI-ANGLE FUNCTION (FOR DVD ONLY)

Press **ANGLE** during playback. Each time the button is pressed, the angle changes in sequential order.

- Notes:
- The angle number is different according to the disc.
 - The function only works for discs having scenes recorded at different angles.
 - When no different angle are recorded, will be displayed at screen left top corner.

MP3 DISC PLAY

MP3 disc is playing as the format of FOLDER.

For example:

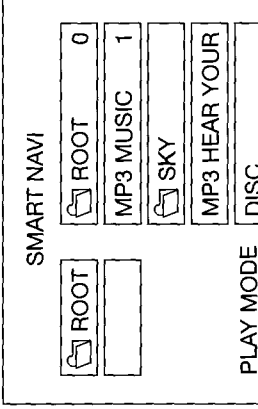

Use on the remote control to select the item or folder, then press ENTER button.

Pressing **REPEAT** button repeatedly can select three kinds of repeat play mode.

REP-ONE:
Play the same song over and over again.

FOLDER REP:
Play all songs in the current directory in sequence, over and over again.

FOLDER:
Play all songs in the current directory once.

When **PLAY MODE** is selected, press to change between the following mode:

- SINGLE REP-ONE FOLDER FOLDER REP
 DISC SCAN DISC DISC REP
 SHUFFLE ON PROGRAM PXXX

During playback, use or to skip an item ahead or back.

: Rapid reverse, : Rapid advance

Note: The **FOLDER** cannot be selected during playing. It can be selected after (Stop) button pressed.

TV OPERATION

Press the **MOD** button on the unit or **MODE** button on the remote control to select TV mode.

When in TV mode, the function of the buttons served in DVD mode is locked.

Searching channels

Repeatedly press **MENU** button to select searching mode. Then use **VOL +/VOL-** buttons or **VOLUME +/-** buttons to start station search. Then press (CH+) button or (CH-) button to stop searching.

Selecting channels

- Press (CH+) button or (CH-) button to choose channel upward or downward.
- The numeric buttons (0,1~9) allow you to select the corresponding channel directly.
- Press digital select button 10+ (-/-) (consecutively used with numeric buttons).

SETUP

INITIAL SETUP

SETUP MENU --- MAIN PAGE

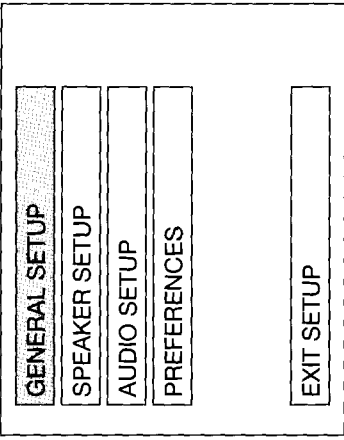

1. Press **SETUP** in the stop mode.
(Press the stop button twice to ensure the player under STOP mode.)

2. The initial **SETUP** menu is displayed.

3. Select the preferred item by using the buttons.

4. Press ENTER buttons.

- a. **GENERAL SETUP**
This setup page includes all the item of TV display & audio output feature. The detail please refer to **GENERAL SETUP MENU.**

- b. **SPEAKER SETUP**
This is to activate the audio output from DOLBY AC3 5.1 DOWNMIX to 2 channel mode. Please refer to **SPEAKER SETUP MENU.**

- c. **AUDIO SETUP**
This setup page includes all the items for **AUDIO**. Please refer to **AUDIO SETUP MENU.**

- d. **PREFERENCE SETUP**
This setup page includes all the configuration of support feature. The detail please refer to **PREFERENCES SETUP MENU.**

GENERAL SETUP

--- GENERAL PAGE ---

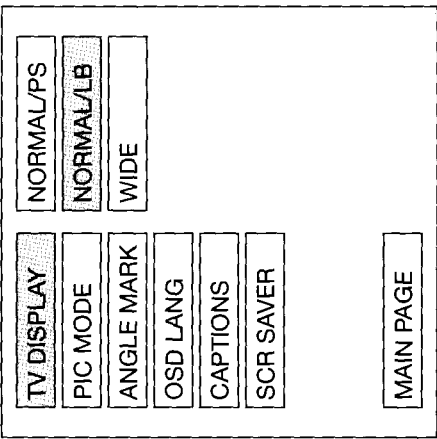

Video Material	TV Screen		
	Normal	4:3	Wide (16:9)
4:3			
16:9			
	Normal	Letter-box	Letter-box

TV display setup

This is to select the appropriate TV aspect (4:3 or 16:9) according to the connected TV set.

Normal/PS (For 4:3 TV)

Played back in the PAN & SCAN style. (If connected to wide-screen TV, the left and right edges are cut off.)

Normal/LB (For 4:3 TV)

Played back in letterbox style. (If connected to wide-screen TV, black bands appear at top and bottom of the screen.)

Wide (For 16:9 TV)

Select when a wide-screen TV set is connected.

SETUP

--- GENERAL PAGE ---

TV DISPLAY
PIC MODE
ANGLE MARK
OSD LANG
CAPTIONS
SCR SAVER
MAIN PAGE

PIC mode setup

Select AUTO, the player PIC mode will depend on DVD disc.
Select HI-RES format for best image resolution.
Select N-FLICKER format on image or picture with or distortion.

--- GENERAL PAGE ---

TV DISPLAY
PIC MODE
ANGLE MARK
OSD LANG
CAPTIONS
SCR SAVER
MAIN PAGE

ANGLE MARK display setup

If it is set to ON, when the multi-angle DVD disc is playing, the angle mark will appear on the screen; if it is set to OFF, the mark will not appear.

--- GENERAL PAGE ---

TV DISPLAY
PIC MODE
ANGLE MARK
OSD LANG
CAPTIONS
SCR SAVER
MAIN PAGE

OSD LANG type setup

Select the preferred OSD (On Screen Display) language by using the \blacktriangle / \blacktriangledown buttons.

--- GENERAL PAGE ---

TV DISPLAY
PIC MODE
ANGLE MARK
OSD LANG
CAPTIONS
SCR SAVER
MAIN PAGE

CAPTIONS setup

Activate the CAPTIONS feature by selecting ON. And deactivate this feature by selecting OFF.

--- GENERAL PAGE ---

TV DISPLAY
PIC MODE
ANGLE MARK
OSD LANG
CAPTIONS
SCR SAVER
MAIN PAGE

SCR SAVER setup

Select the SCR SAVER output ON/OFF.

AUDIO SETUP

--- AUDIO SETUP ---

SPDIF
OP MODE
DYNAMIC
LPCM OUTPUT
OFF
ON
MAIN PAGE

AUDIO OUT

This is to activate the audio output from ANALOG mode to SPDIF/RAW mode to SPDIF/PCM mode.

--- AUDIO SETUP ---

AUDIO OUT
OP MODE
DYNAMIC
LPCM OUTPUT
LINE OUT
RF REMOD
MAIN PAGE

OP MODE

There are two operating modes for the Dolby Digital decoder: LINE OUT and RF REMOD.

SPEAKER SETUP

--- SPEAKER SETUP PAGE ---

DOWNMIX
LT/RT
STEREO
MAIN PAGE

DOWNMIX

This is to activate the audio output from DOLBY AC3 5.1 DOWNMIX to 2 channel mode.

Select the preferred SPEAKER

connection by using the cursor buttons.

- Select the LT/RT to activate the Dolby surround compatible output.

- Select the STEREO to activate simple stereo mode.

--- AUDIO SETUP ---

AUDIO OUT	FULL
OP MODE	6/8
DYNAMIC	4/8
LPCM OUTPUT	2/8
	OFF
MAIN PAGE	

Dynamic Range Control

Select **DYNAMIC** and adjust the dynamic range of a Dolby Digital encoded program. There are 8 steps between full compression and off compression.

--- AUDIO SETUP ---

AUDIO OUT	LPCM 48K
OP MODE	LPCM 96K
DYNAMIC	
LPCM OUTPUT	
MAIN PAGE	

LPCM OUTPUT

Select the **LPCM OUTPUT** between LPCM 48K and LPCM 96K.

PREFERENCES SETUP

--- PREFERENCES PAGE ---

TV TYPE	AUTO
AUDIO	NTSC
SUBTITLE	PAL
DISC MENU	
PARENTAL	
PASSWORD	
DEFAULTS	
SMART NAV	
LOGO	
MAIN PAGE	

TV type setup

This player can play discs recorded in either PAL or NTSC format.

Select **NTSC** format, when you connected to **NTSC** TV.
Select **PAL** format, when you connected to **PAL** TV.
Select **AUTO** format, the player TV output format will be according to the DVD disc format.

--- PREFERENCES PAGE ---

TV TYPE	ENGLISH
AUDIO	FRENCH
SUBTITLE	SPANISH
DISC MENU	CHINESE
PARENTAL	JAPANESE
PASSWORD	GERMAN
DEFAULTS	ITALIAN
SMART NAV	
LOGO	
MAIN PAGE	

AUDIO language setup

Select the preferred **AUDIO** soundtrack by using the cursor buttons.

--- PREFERENCES PAGE ---

TV TYPE	ENGLISH
AUDIO	FRENCH
SUBTITLE	SPANISH
DISC MENU	CHINESE
PARENTAL	JAPANESE
PASSWORD	GERMAN
DEFAULTS	ITALIAN
SMART NAV	OFF
LOGO	
MAIN PAGE	

SUBTITLE language setup

Select the preferred **SUBTITLE** language by using the cursor buttons.

--- PREFERENCES PAGE ---

TV TYPE	ENGLISH
AUDIO	FRENCH
SUBTITLE	SPANISH
DISC MENU	CHINESE
PARENTAL	JAPANESE
PASSWORD	GERMAN
DEFAULTS	ITALIAN
SMART NAV	
LOGO	
MAIN PAGE	

DISC MENU language setup

Select the preferred **DISC MENU** language by using the cursor buttons.

--- PREFERENCES PAGE ---

TV TYPE	1 G
AUDIO	2
SUBTITLE	3 PG
DISC MENU	4 PG 13
PARENTAL	5
PASSWORD	6 PG-R
DEFAULTS	7 NC-17
SMART NAV	8 ADULT
LOGO	NO_PARENTAL
MAIN PAGE	

PARENTAL

Select suitable parental guidance by the cursor buttons and confirm by pressing **ENTER** button.

--- PREFERENCES PAGE ---

TV TYPE	CHANGE
AUDIO	
SUBTITLE	
DISC MENU	
PARENTAL	
PASSWORD	
DEFAULTS	
SMART NAV	
LOGO	
MAIN PAGE	

PASSWORD

Select **CHANGE** and press **ENTER** button. Type the old password (The initial factory code is 3308) and key in 4 characters password now you want to use, and retype again to confirm key in correctly.

SETUP

--- PREFERENCES PAGE ---

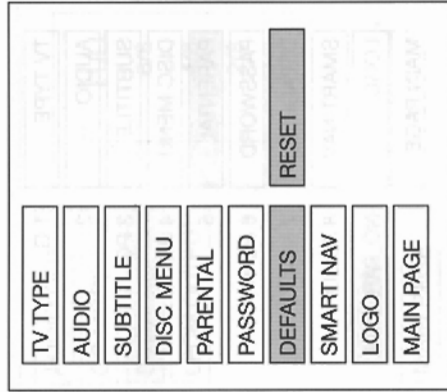

DEFAULTS

Select reset to become factory initial setting.

--- PREFERENCES PAGE ---

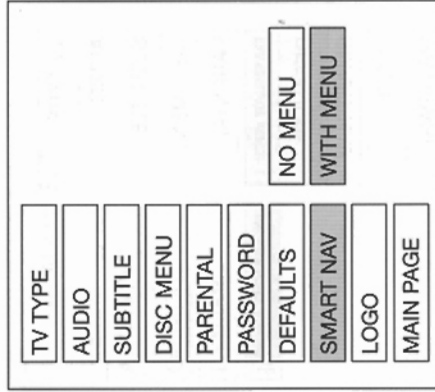

SMART NAV

In this item, you can select NO MENU mode or WITH MENU mode.

TROUBLE SHOOTING

If it appears that your DVD unit is faulty, first consult this checklist. It may be that something simple has been overlooked.

Under no circumstances should you try to repair the player yourself, as this will invalidate the warranty. Only qualified service personnel can remove the cover or service this player.

NO POWER

- Check if the on/off button on the front of the player is set to on.

NO PICTURE

- Check if the mode is set to proper state, such as DVD mode and AV mode.
- Check the video connection.

DISTORTED PICTURE

- Check the disc for fingerprints and clean with soft cloth, wiping from centre to edge.
- Sometimes a small amount of picture distortion may appear. This is not a malfunction.

COMPLETELY DISTORTED PICTURE

- The disc format is not according to the TV-set used (PAL/NTSC).

NO COLOR IN PICTURE

- The disc format is not according to the TV-set used (PAL/NTSC).

DISC DOES NOT PLAY

- Ensure the disc label is upwards.
- Clean the disc.
- Check if the disc is defective by trying another disc.

NO SOUND

- Check audio connections.
- If using a HiFi amplifier, try another sound source.

DISTORTED SOUND FROM HIFI AMPLIFIER

- Check to make sure that no audio connections are made to the amplifier phono input.

NO RETURN TO START-UP SCREEN WHEN DISC IS REMOVED

- Press POWER to turn off the unit, then press it again to turn on the unit.

THE PLAYER DOES NOT RESPOND TO THE REMOTE CONTROL

- Aim the remote control directly at the sensor on the front of the player.
- Avoid all obstacles which may interfere with the signal path.
- Inspect or replace the remote control batteries.

DISTORTED OR B/W PICTURE

- The disc format is not according to the TV-set used (PAL/NTSC).

NO AUDIO AT DIGITAL OUTPUT

- Check the digital connections.
- Check the Digital Audio menu to make sure that the digital output is correctly set.
- Check if the audio format of the selected audio language matches your receiver capabilities.

BUTTONS DO NOT WORK

- Turn the player off and on with the power on/off button on the front of the player.

--- PREFERENCES PAGE ---

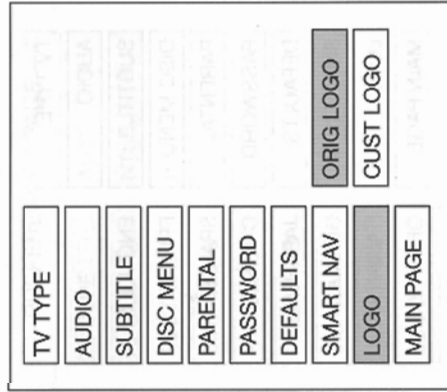

LOGO

Select ORIG LOGO (original picture when turn on the unit) or CUST LOGO (customer-set picture when turn on the unit).

DEFAULTS TABLE

General Setup	TV Display	Normal/LB
	PIC Mode	AUTO
	Angle Mark	ON
	OSD Language	English
	Captions	ON
	SCR Saver	ON
Speaker Setup	Downmix	Stereo
Audio Setup	Audio Out	SPDIF/RAW
	OP Mode	Line Out
	Dynamic	FULL
	LPCM Output	LPCM 96K
Preferences	TV Type	AUTO
	Audio	English
	Subtitle	English
	DISC Menu	English
	Parental	NO_Parental
	Password	3308
	Smart NAV	With Menu
	Logo	Orig Logo

SPECIFICATIONS

Supply Voltage	: 12V DC (11V-15V), test voltage 14.4V, negative ground
Current Consumption	: Less than 2A
Signal System	: Composite video 1.0Vp-p 75 Ω
Discs Played	: (1) DVD-VIDEO Disc 5" (12 cm) single-sided, single-layer 5" (12 cm) single-sided, double-layer (2) Compact Disc (CD-DA/CD-R/CD-RW/MP3) (3) 5" (12cm) Video CD
Audio Output Level	: 10k Ω (2 ch 2.0 Vrms)
Audio Signal Output Characteristics	: (1) Frequency Response 20 Hz - 20 KHz : (2) S/N Ratio 80 dB (JIS) : (3) Wow and Flutter Below measurable limits

Note:

Specifications and design are subject to modification, without notice, due to improvements in technology.

This product incorporates copyright protection technology that is protected by method claims of certain U.S. patents and other intellectual property rights owned by Macrovision Corporation and other rights owners. Use of this copyright protection technology must be authorized by Macrovision Corporation, and is intended for home and other limited viewing uses only unless otherwise authorized by Macrovision Corporation. Reverse engineering or disassembly is prohibited.